

2010 Vulcan® 2000 Classic LT PARTS DIAGRAM

Crankcase

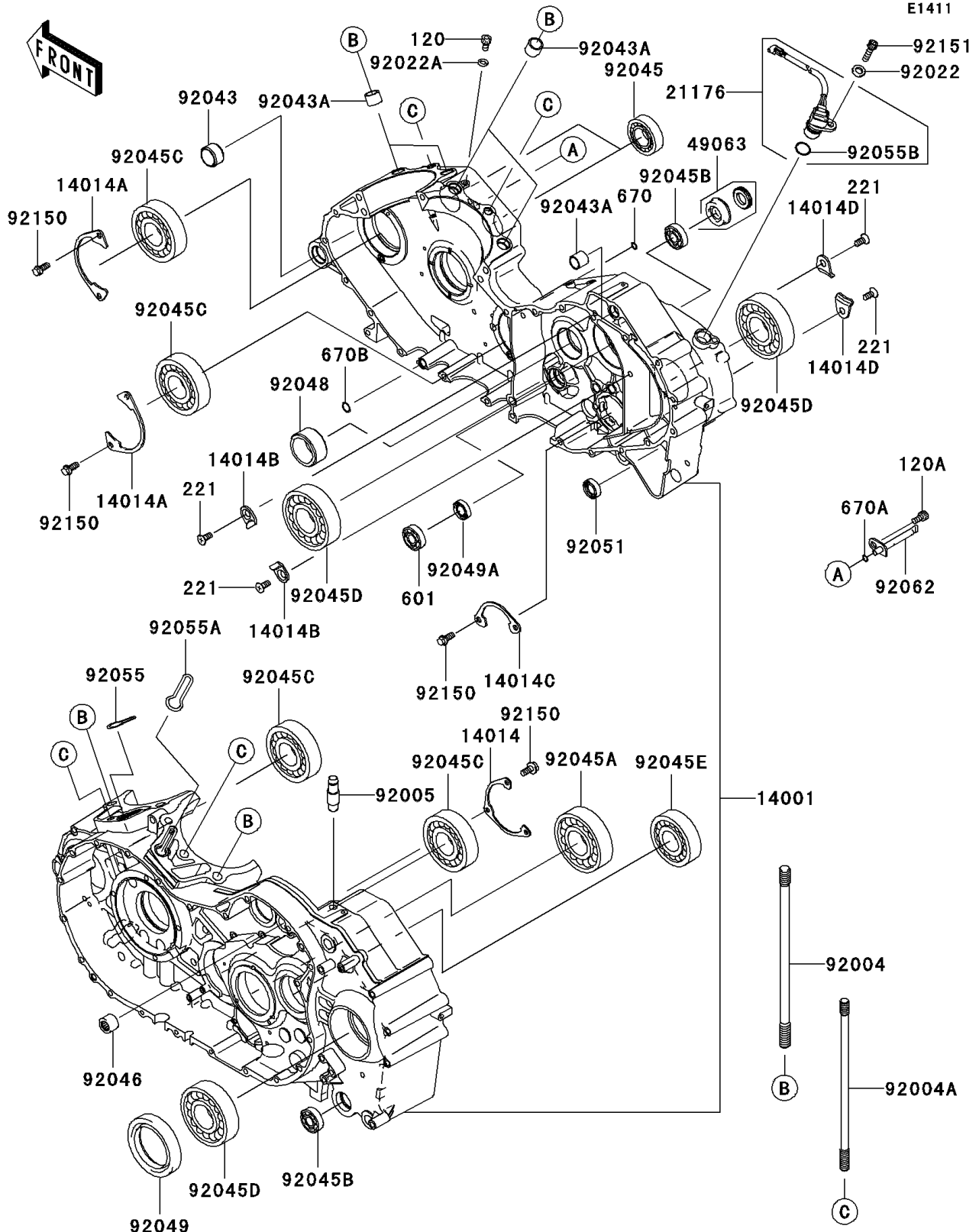

2010 Vulcan® 2000 Classic LT PARTS LIST

Crankcase

ITEM NAME	PART NUMBER	QUANTITY
BOLT-SOCKET,6X10 (Ref # 120)	120R0610	1
BOLT-SOCKET,6X12 (Ref # 120A)	120R0612	1
SCREW-CSK-CROS,6X14 (Ref # 221)	221AA0614	4
BEARING-BALL (Ref # 601)	601A6001	1
O RING (Ref # 670)	670D1505	1
O RING,6MM (Ref # 670A)	670D1506	1
O RING (Ref # 670B)	670D2010	1
SET-CRANKCASE (Ref # 14001)	14001-5392	1
PLATE-POSITION (Ref # 14014)	14014-0001	1
PLATE-POSITION (Ref # 14014A)	14014-0002	2
PLATE-POSITION (Ref # 14014B)	14014-0003	2
PLATE-POSITION (Ref # 14014C)	14014-0004	1
PLATE-POSITION (Ref # 14014D)	14014-0011	2
SENSOR,SPEED (Ref # 21176)	21176-0038	1
SEAL-MECHANICAL,WATER (Ref # 49063)	49063-1055	1
STUD,12X217 (Ref # 92004)	92004-0008	8
STUD,10X206 (Ref # 92004A)	92004-0009	4
FITTING,BREATHER (Ref # 92005)	92005-0015	1
WASHER,6.5X11.5X2 (Ref # 92022)	92022-1506	1
WASHER,6.2X11X1 (Ref # 92022A)	92022-304	1
PIN,24X14 (Ref # 92043)	92043-0032	1
PIN,13X16X14 (Ref # 92043A)	92043-1608	5
BEARING-BALL,60/22 (Ref # 92045)	92045-0002	2
BEARING-BALL,6306LU (Ref # 92045A)	92045-0022	1
BEARING-BALL,6001JRXLLU/5K (Ref # 92045B)	92045-1151	2
BEARING-BALL,63/28 (Ref # 92045C)	92045-1189	4
BEARING-BALL,6306SH2 (Ref # 92045D)	92045-1190	3
BEARING-BALL,6305RHR4SH2 (Ref # 92045E)	92045-1254	1
BEARING-NEEDLE,HK1212 (Ref # 92046)	92046-1163	1

2010 Vulcan® 2000 Classic LT PARTS LIST

Crankcase

ITEM NAME	PART NUMBER	QUANTITY
RACE (Ref # 92048)	92048-1103	1
SEAL-OIL (Ref # 92049)	92049-0010	1
SEAL-OIL,SC 12X22X5 (Ref # 92049A)	92049-1228	1
SEAL-OIL,TB13225.5 (Ref # 92051)	92051-005	1
RING-O,FR CYLINDER BASE (Ref # 92055)	92055-0007	1
RING-O,RR CYLINDER BASE (Ref # 92055A)	92055-0008	1
RING-O (Ref # 92055B)	92055-1638	1
NOZZLE (Ref # 92062)	92062-0002	1
BOLT,6X14 (Ref # 92150)	92150-1916	9
BOLT,SOCKET,6X20 (Ref # 92151)	92151-3774	1