

2010 Vulcan® 2000 Classic LT PARTS DIAGRAM

Fuel Pump

E1520

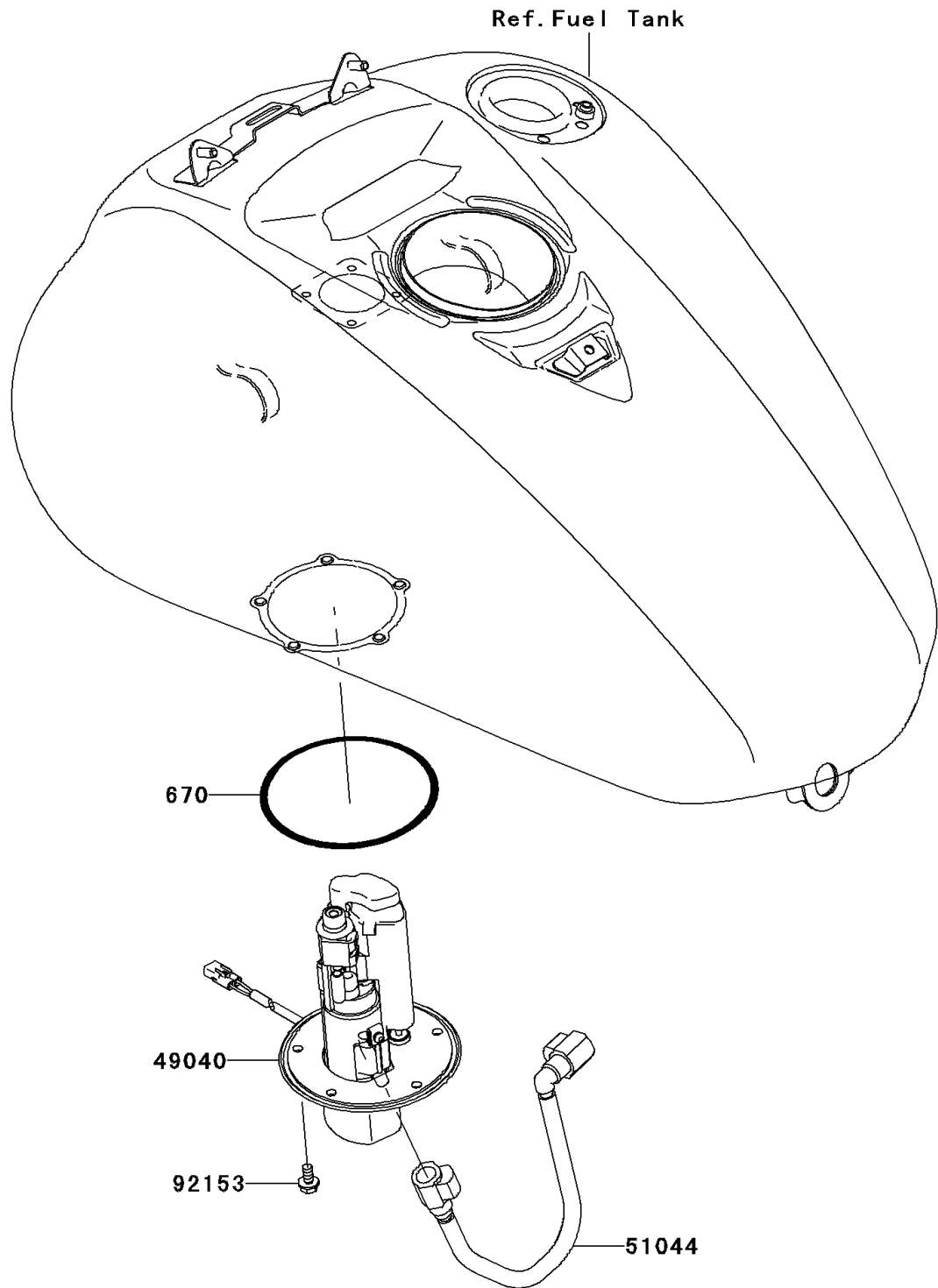

2010 Vulcan® 2000 Classic LT PARTS LIST

Fuel Pump

ITEM NAME	PART NUMBER	QUANTITY
O RING (Ref # 670)	670E5075	1
PUMP-FUEL (Ref # 49040)	49040-0016	1
TUBE-ASSY (Ref # 51044)	51044-0013	1
BOLT,FLANGED,6X12 (Ref # 92153)	92153-1283	5