

# 2003 Vulcan 800 Classic PARTS DIAGRAM

Air Cleaner

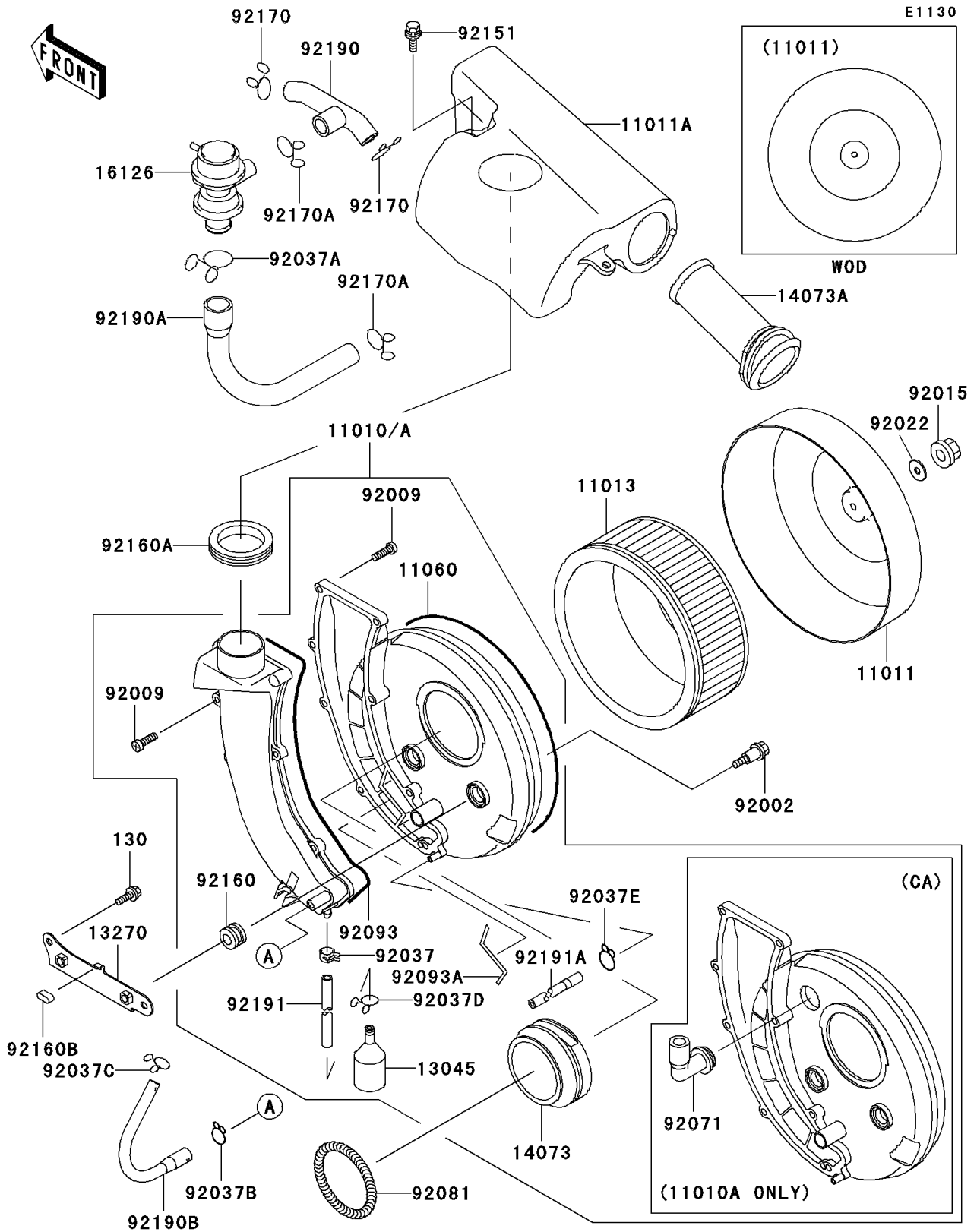

## 2003 Vulcan 800 Classic PARTS LIST

### Air Cleaner

ITEM NAME	PART NUMBER	QUANTITY
BOLT-FLANGED,6X16,BLACK (Ref # 130)	130J0616	2
CASE-AIR FILTER,COVER (Ref # 11011)	11011-1453	1
CASE-AIR FILTER,CHAMBER (Ref # 11011A)	11011-1454	1
ELEMENT-AIR FILTER (Ref # 11013)	11013-1243	1
GASKET,AIR FILTER (Ref # 11060)	11060-1721	1
RECEIVER-OIL (Ref # 13045)	13045-1057	1
PLATE,AIR FILTER CASE (Ref # 13270)	13270-1388	1
DUCT,AIR FILTER (Ref # 14073)	14073-1622	1
DUCT,AIR FILTER CHAMBER (Ref # 14073A)	14073-1623	1
VALVE,AIR SWITCH (Ref # 16126)	16126-1289	1
BOLT (Ref # 92002)	92002-1595	2
SCREW,TAPPING,5X20 (Ref # 92009)	92009-1399	8
NUT,CAP,6MM (Ref # 92015)	92015-1385	1
WASHER,6.5X20X1.6,WHITE (Ref # 92022)	92022-193	1
CLAMP,TUBE (Ref # 92037)	92037-010	1
CLAMP,TUBE (Ref # 92037A)	92037-1076	1
CLAMP,FUEL TUBE (Ref # 92037B)	92037-1271	1
CLAMP,TUBE (Ref # 92037C)	92037-147	1
CLAMP (Ref # 92037D)	92037-1712	1
CLAMP,TUBE (Ref # 92037E)	92037-3025	1
SPRING,DUCT (Ref # 92081)	92081-1638	1
SEAL,AIR FILTER (Ref # 92093)	92093-1501	1
SEAL,AIR FILTER (Ref # 92093A)	92093-1502	1
BOLT (Ref # 92151)	92151-1579	2
DAMPER (Ref # 92160)	92160-1594	2
DAMPER (Ref # 92160A)	92160-1600	1
DAMPER,PLATE (Ref # 92160B)	92160-1605	1
CLAMP (Ref # 92170)	92170-1017	2
CLAMP,TUBE (Ref # 92170A)	92170-1445	2

## 2003 Vulcan 800 Classic PARTS LIST

### Air Cleaner

ITEM NAME	PART NUMBER	QUANTITY
TUBE,AIR SWITCH-HEAD (Ref # 92190)	92190-1600	1
TUBE,AIR SWITCH-FILTER CASE (Ref # 92190A)	92190-1601	1
TUBE,BREATHER (Ref # 92190B)	92190-1602	1
TUBE,6X9X345 (Ref # 92191)	92191-1111	1
TUBE (Ref # 92191A)	92191-1112	1
FILTER-ASSY-AIR (Ref # 11010)	11010-1670	1
FILTER-ASSY-AIR (Ref # 11010A)	11010-1671	1
GROMMET,AIR FILTER (Ref # 92071)	92071-1114	1