

2003 Vulcan 800 Classic PARTS DIAGRAM

Frame Fittings

F2131

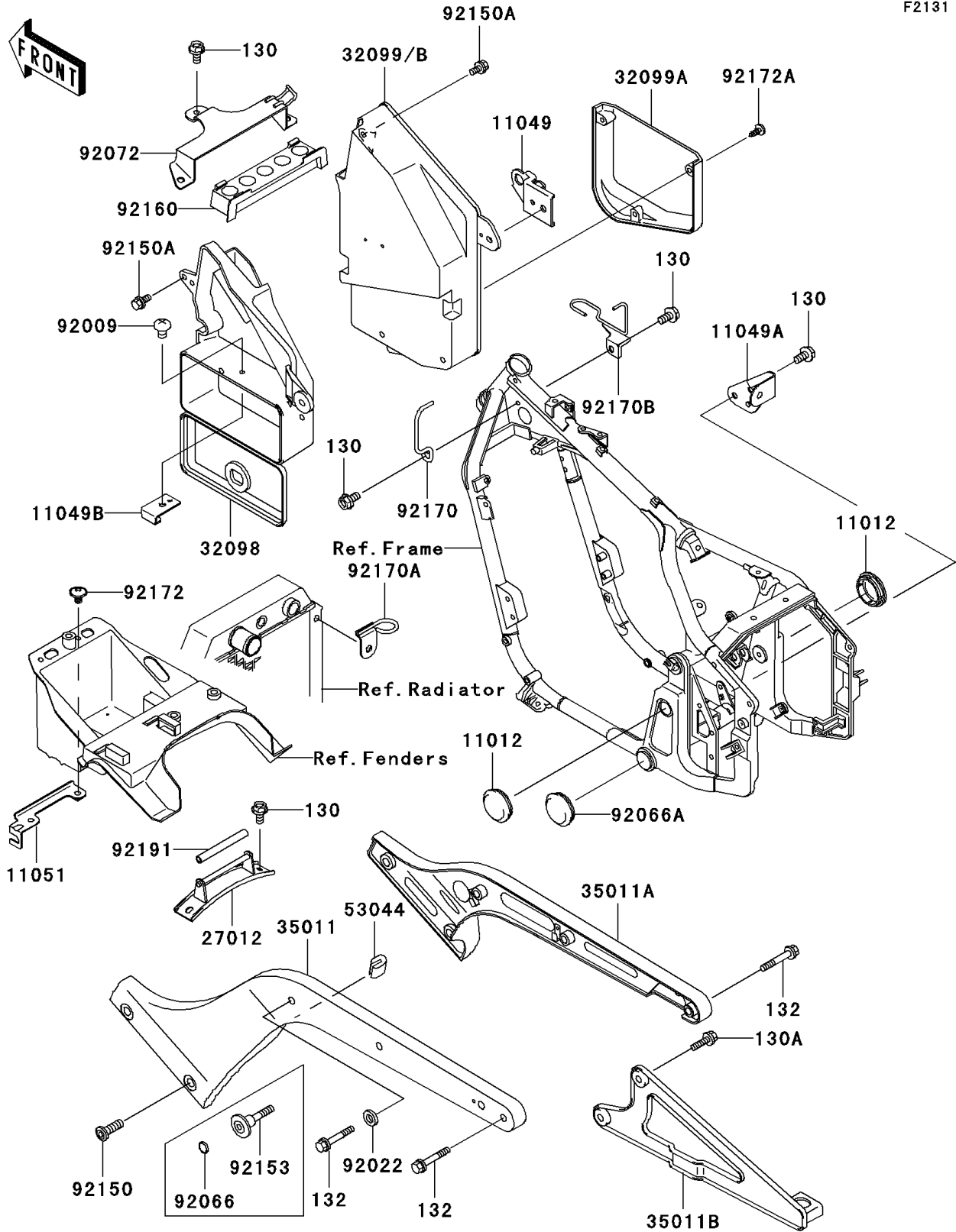

2003 Vulcan 800 Classic PARTS LIST

Frame Fittings

ITEM NAME	PART NUMBER	QUANTITY
BOLT-FLANGED (Ref # 130)	130J0612	8
BOLT-FLANGED,8X20 (Ref # 130A)	130J0820	2
BOLT-FLANGED-SMALL (Ref # 132)	132E0835	6
CAP (Ref # 11012)	11012-1926	2
BRACKET,SIDE COVER LOCK (Ref # 11049)	11049-1183	1
BRACKET,RESERVOIR TANK (Ref # 11049A)	11049-1233	1
BRACKET,TOOL CASE LOCK (Ref # 11049B)	11049-1266	1
BRACKET,STARTER CABLE (Ref # 11051)	11051-1328	1
HOOK,SEAT (Ref # 27012)	27012-1495	1
CASE-TOOL (Ref # 32098)	32098-1106	1
CASE (Ref # 32099A)	32099-1164	1
STAY,LH (Ref # 35011)	35011-1725	1
STAY,RH (Ref # 35011A)	35011-1726	1
STAY,MUFFLER (Ref # 35011B)	35011-1727	1
TRIM,L=20 (Ref # 53044)	53044-1292	2
SCREW,5X14 (Ref # 92009)	92009-1653	1
WASHER (Ref # 92022)	92022-1823	2
PLUG (Ref # 92066)	92066-1277	2
PLUG (Ref # 92066A)	92066-1434	1
BAND,BATTERY (Ref # 92072)	92072-1320	1
BOLT,SOCKET,10X30 (Ref # 92150)	92150-1517	4
BOLT,FLANGED,6X14 (Ref # 92150A)	92150-1689	7
BOLT,BUNGEE CORD HOOK (Ref # 92153)	92153-1100	2
DAMPER,BATTERY BAND (Ref # 92160)	92160-1634	1
CLAMP,HARNESS (Ref # 92170)	92170-1605	1
CLAMP,CABLE (Ref # 92170A)	92170-1608	1
CLAMP,HARNESS&CABLE (Ref # 92170B)	92170-1622	1
SCREW,6X10 (Ref # 92172)	92172-0005	2
SCREW,TAPPING,5X14 (Ref # 92172A)	92172-0006	3

2003 Vulcan 800 Classic PARTS LIST

Frame Fittings

ITEM NAME	PART NUMBER	QUANTITY
TUBE,6X10X80 (Ref # 92191)	92191-1009	1
CASE,BASE (Ref # 32099)	32099-1163	1
CASE,BASE (Ref # 32099B)	32099-1167	1