

# 2010 Vulcan® 2000 Classic LT PARTS DIAGRAM

Ignition System

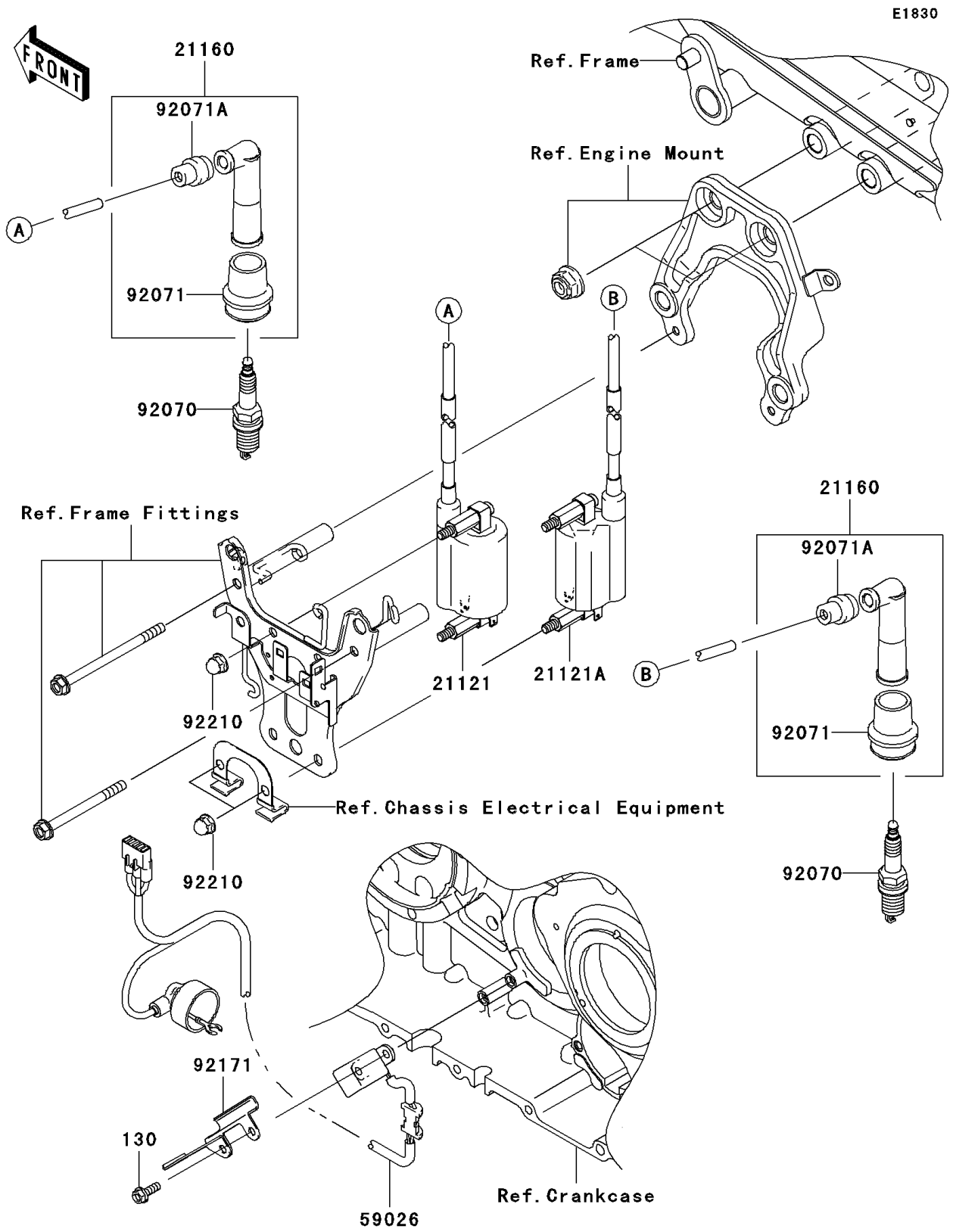

## 2010 Vulcan® 2000 Classic LT PARTS LIST

### Ignition System

ITEM NAME	PART NUMBER	QUANTITY
BOLT-FLANGED,5X14 (Ref # 130)	130BA0514	2
COIL-IGNITION,FR ENGINE (Ref # 21121)	21121-0013	1
COIL-IGNITION,RR ENGINE (Ref # 21121A)	21121-0014	1
CAP-ASSY-PLUG (Ref # 21160)	21160-0005	2
COIL-PULSING (Ref # 59026)	59026-0002	1
PLUG-SPARK,IZFR6F11(NGK) (Ref # 92070)	92070-0007	2
GROMMET,PLUG CAP (Ref # 92071)	92071-0006	2
GROMMET,HIGH TENSION (Ref # 92071A)	92071-0010	2
CLAMP,COIL WIRE (Ref # 92171)	92171-0035	1
NUT,CAP,6MM (Ref # 92210)	92210-0003	4