

2001 Vulcan 800 Classic PARTS DIAGRAM

Taillight(s)

F2720

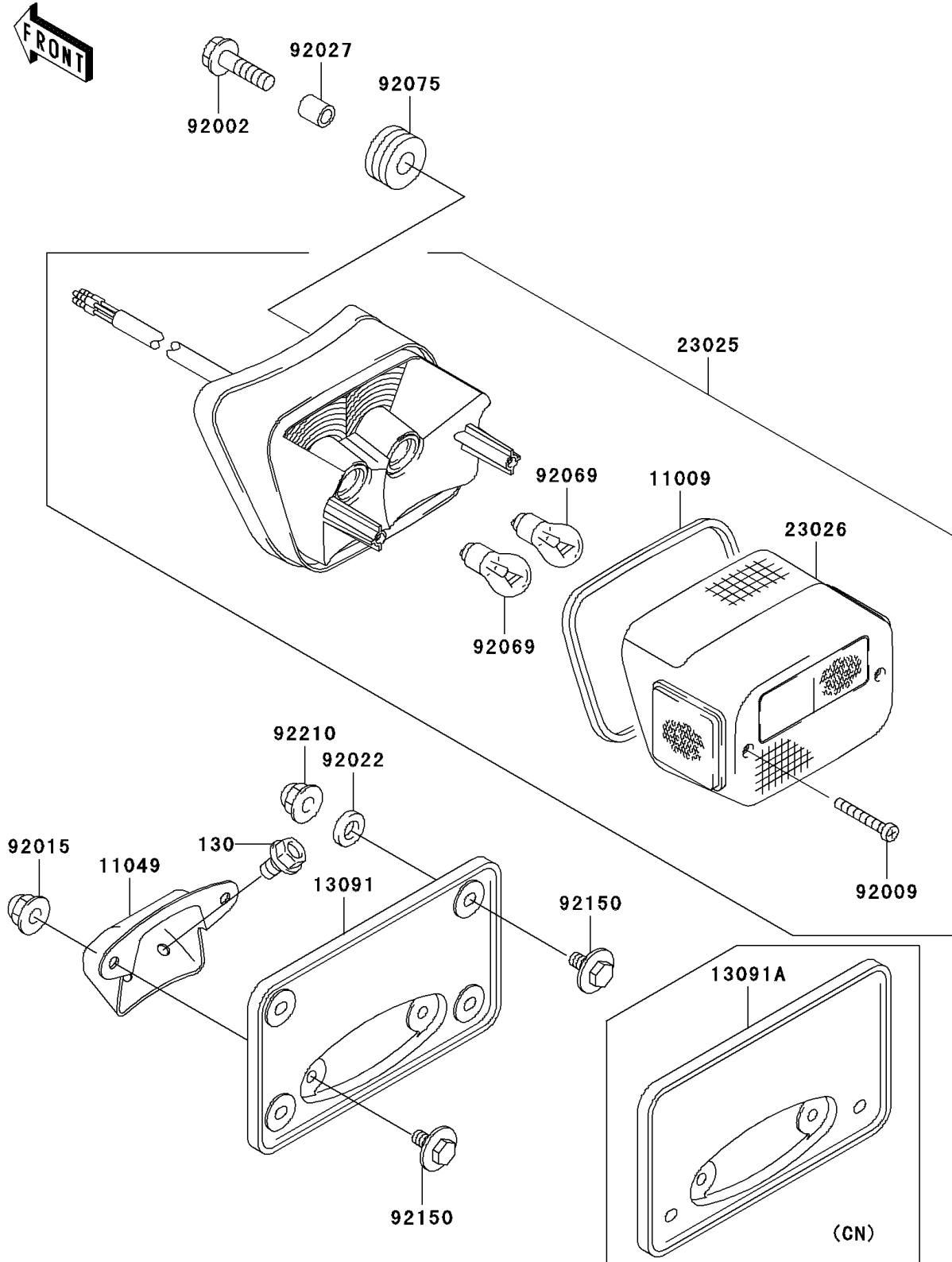

2001 Vulcan 800 Classic PARTS LIST

Taillight(s)

| ITEM NAME | PART NUMBER | QUANTITY |
|---------------------------------------|-------------|----------|
| BOLT-FLANGED,6X10 (Ref # 130) | 130V0610 | 2 |
| GASKET,TAIL LAMP LENS (Ref # 11009) | 11009-1660 | 1 |
| BRACKET,LICENSE PLATE (Ref # 11049) | 11049-1436 | 1 |
| LAMP-TAIL (Ref # 23025) | 23025-1296 | 1 |
| LENS,TAIL LAMP (Ref # 23026) | 23026-1087 | 1 |
| BOLT,6X22 (Ref # 92002) | 92002-1262 | 3 |
| SCREW,TAPPING,4X20 (Ref # 92009) | 92009-1378 | 2 |
| NUT,CAP,6MM (Ref # 92015) | 92015-1385 | 2 |
| COLLAR,6.8X10X12 (Ref # 92027) | 92027-162 | 3 |
| BULB,12V 21/5W (Ref # 92069) | 92069-063 | 2 |
| DAMPER (Ref # 92075) | 92075-209 | 3 |
| HOLDER,LICENSE PLATE (Ref # 13091) | 13091-1500 | 1 |
| HOLDER,LICENSE PLATE (Ref # 13091A) | 13091-1952 | 1 |
| WASHER,6.5X20X1.6,BLACK (Ref # 92022) | 92022-1346 | 2 |
| WASHER,6.5X20X1.6,BLACK (Ref # 92022) | 92022-1346 | 4 |
| BOLT,6X14 (Ref # 92150) | 92150-1133 | 4 |
| BOLT,6X14 (Ref # 92150) | 92150-1133 | 6 |
| NUT,CAP,6MM (Ref # 92210) | 92210-0003 | 2 |
| NUT,CAP,6MM (Ref # 92210) | 92210-0003 | 4 |