

2001 Vulcan 800 Drifter PARTS DIAGRAM

Cylinder Head

E1111

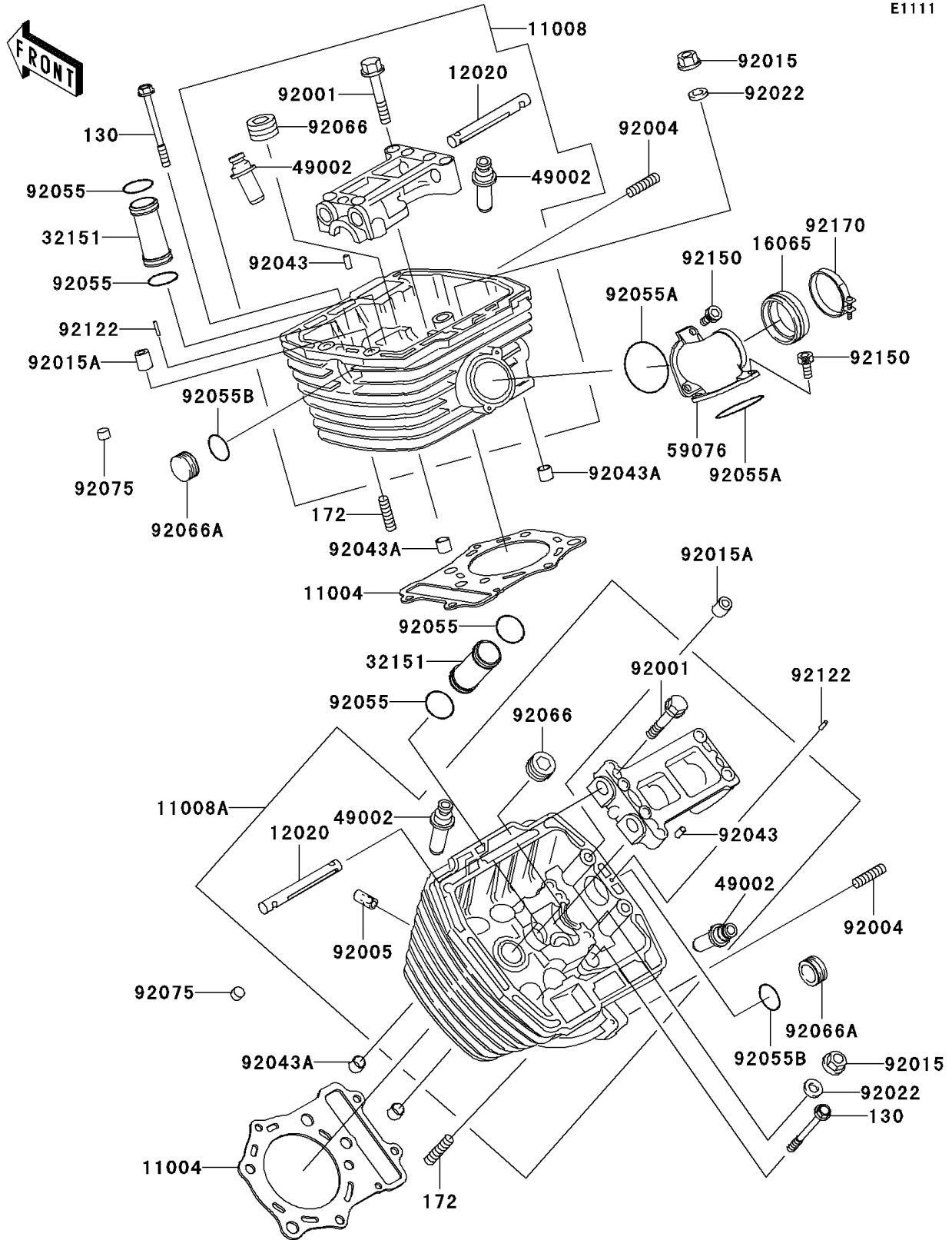

2001 Vulcan 800 Drifter PARTS LIST

Cylinder Head

ITEM NAME	PART NUMBER	QUANTITY
BOLT-FLANGED (Ref # 130)	130S0665	2
BOLT-STUD,8X25 (Ref # 172)	172G0825	4
GASKET-HEAD (Ref # 11004)	11004-1310	2
HEAD-COMP-CYLINDER,FR (Ref # 11008)	11008-1301	1
HEAD-COMP-CYLINDER,RR (Ref # 11008A)	11008-1302	1
SHAFT-ROCKER (Ref # 12020)	12020-1070	4
HOLDER-CARBURETOR (Ref # 16065)	16065-1308	1
PIPE,PLUG (Ref # 32151)	32151-1893	2
GUIDE-VALVE (Ref # 49002)	49002-1097	AR
MANIFOLD-INTAKE (Ref # 59076)	59076-1107	1
BOLT,FLANGED,8X58 (Ref # 92001)	92001-1005	8
STUD,8X22 (Ref # 92004)	92004-1217	4
FITTING,BREATHER PIPE (Ref # 92005)	92005-1061	1
NUT,FLANGED,10MM (Ref # 92015)	92015-077	8
NUT (Ref # 92015A)	92015-1923	4
WASHER,10.5X20X1.6 (Ref # 92022)	92022-1591	8
PIN,6.2X8X14 (Ref # 92043)	92043-1263	4
PIN,11X14X12.3 (Ref # 92043A)	92043-1266	4
RING-O,27.7X1.9 (Ref # 92055)	92055-1272	4
RING-O,44.7X2.4 (Ref # 92055A)	92055-1279	2
RING-O,ID=24.5 (Ref # 92055B)	92055-1459	2
PLUG,PT1/2X12.5 (Ref # 92066)	92066-0002	2
PLUG,CAM HOLE (Ref # 92066A)	92066-1462	2
DAMPER (Ref # 92075)	92075-182	33
ROLLER,3X15.8 (Ref # 92122)	92122-1126	2
BOLT,SOCKET,6X20 (Ref # 92150)	92150-1880	4
CLAMP (Ref # 92170)	92170-1632	1