

2003 Vulcan 800 Drifter PARTS DIAGRAM

Muffler(s)

E1140

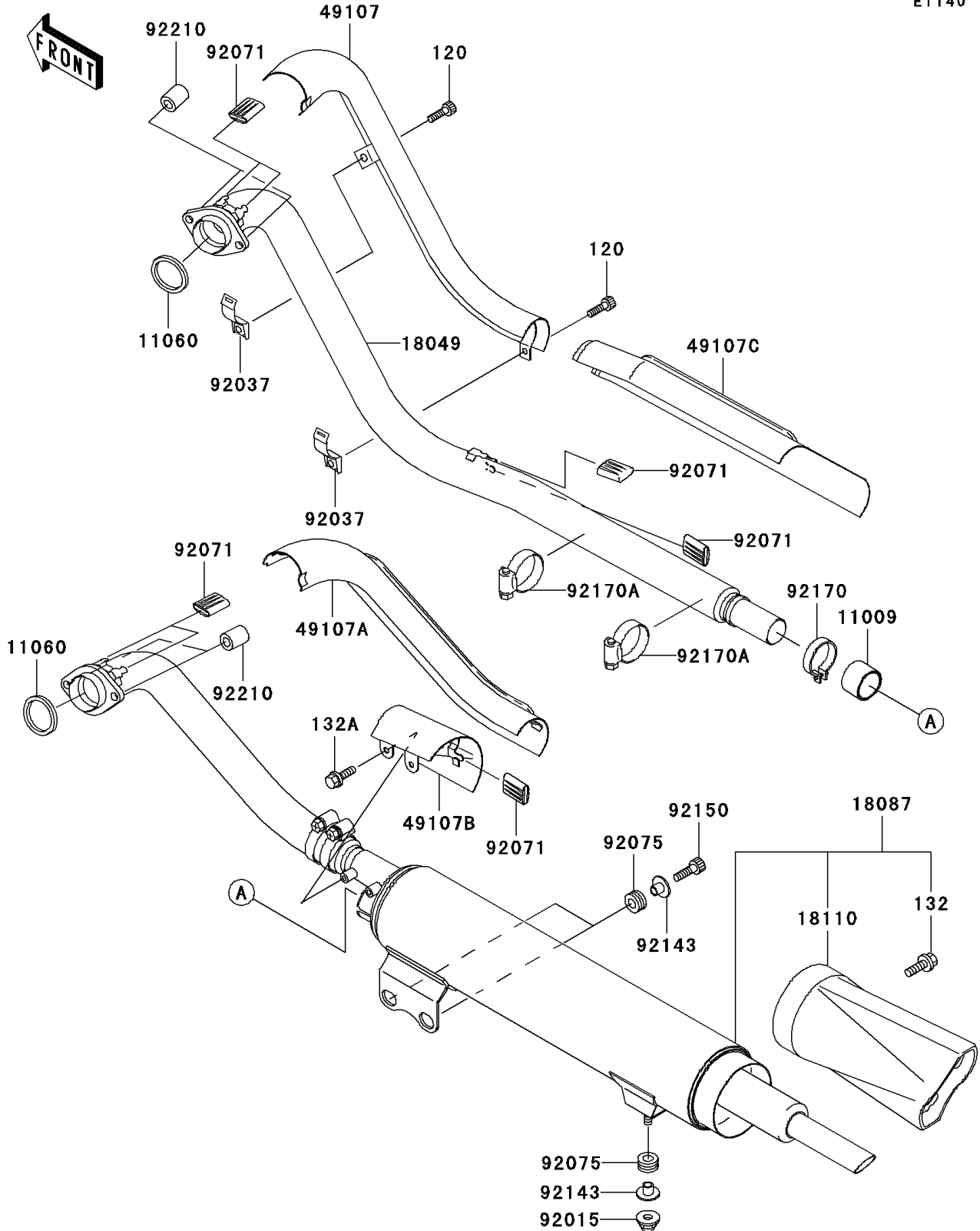

2003 Vulcan 800 Drifter PARTS LIST

Muffler(s)

ITEM NAME	PART NUMBER	QUANTITY
BOLT-SOCKET (Ref # 120)	120Z0620	2
BOLT-FLANGED-SMALL (Ref # 132)	132Y0610	3
BOLT-FLANGED-SMALL (Ref # 132A)	132Y0612	2
GASKET,MUFFLER CONNECTING (Ref # 11009)	11009-1865	1
GASKET,EXHAUST PIPE (Ref # 11060)	11060-1680	2
PIPE-EXHAUST,FR (Ref # 18049)	18049-1899	1
MUFFLER (Ref # 18087)	18087-1069	1
BODY END-MUFFLER (Ref # 18110)	18110-1151	1
COVER-EXHAUST PIPE,FR (Ref # 49107)	49107-1163	1
COVER-EXHAUST PIPE,RR (Ref # 49107A)	49107-1164	1
COVER-EXHAUST PIPE,JOINT (Ref # 49107B)	49107-1165	1
COVER-EXHAUST PIPE,FR (Ref # 49107C)	49107-1174	1
NUT,CAP,8MM (Ref # 92015)	92015-1370	1
CLAMP,EXHAUST PIPE COVER (Ref # 92037)	92037-1613	2
GROMMET (Ref # 92071)	92071-1226	7
DAMPER (Ref # 92075)	92075-1898	3
COLLAR (Ref # 92143)	92143-1753	3
BOLT,SOCKET,8X25 (Ref # 92150)	92150-1912	2
CLAMP,MUFFLER (Ref # 92170)	92170-1454	1
CLAMP (Ref # 92170A)	92170-1964	2
NUT (Ref # 92210)	92210-1273	4