

2003 Vulcan 800 Drifter PARTS DIAGRAM

Gear Change Mechanism

E1370

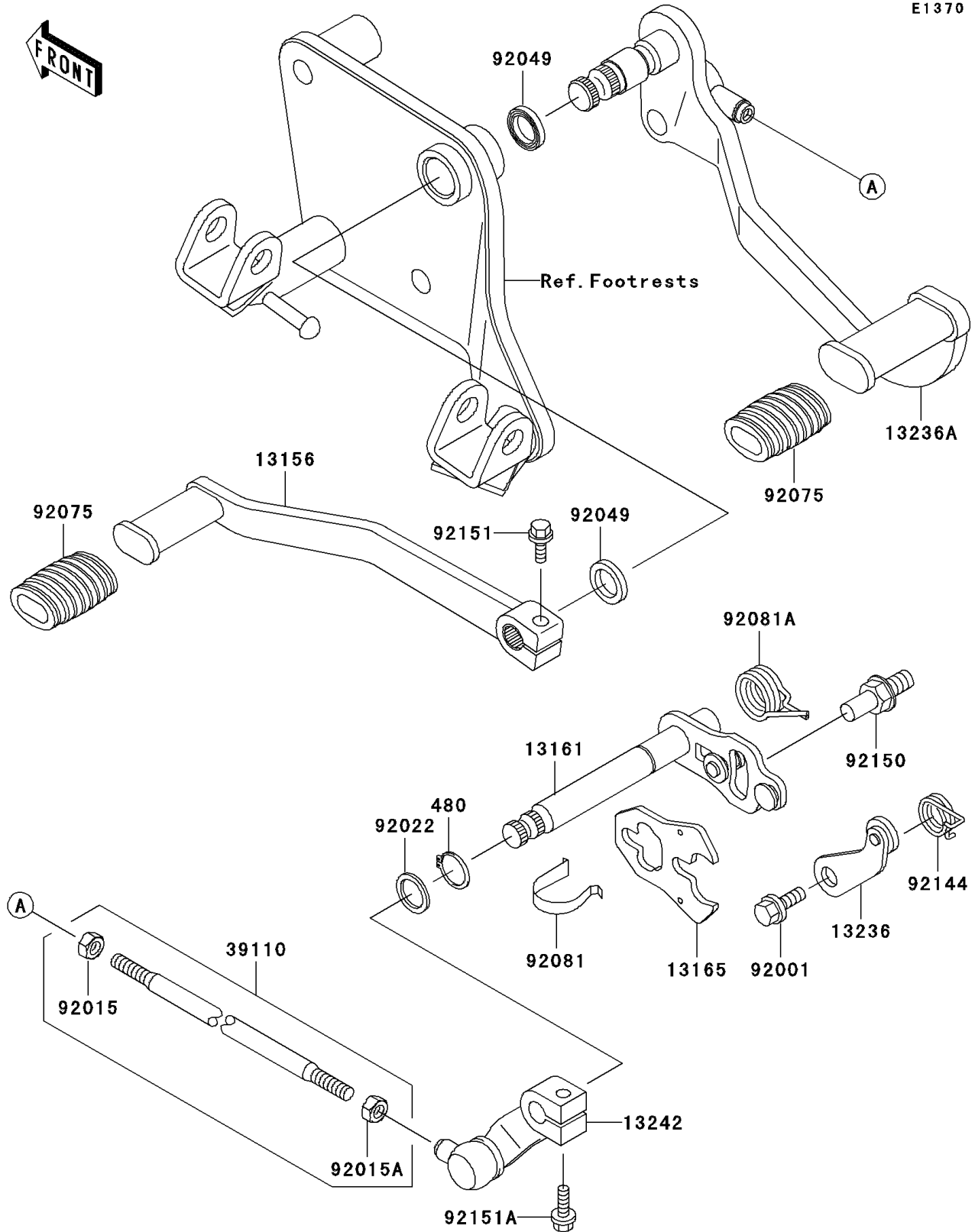

2003 Vulcan 800 Drifter PARTS LIST

Gear Change Mechanism

ITEM NAME	PART NUMBER	QUANTITY
CIRCLIP-TYPE-C,13MM (Ref # 480)	480J1300	1
LEVER-CHANGE,PEDAL (Ref # 13156)	13156-1464	1
LEVER-COMP-CHANGE SHAFT (Ref # 13161)	13161-1218	1
PAWL,CHANGE LEVER (Ref # 13165)	13165-1151	1
LEVER-COMP,POSITION (Ref # 13236)	13236-1126	1
LEVER-COMP,CHANGE (Ref # 13236A)	13236-1364	1
LEVER-ASSY-CHANGE (Ref # 13242)	13242-1290	1
ROD-ASSY-TIE (Ref # 39110)	39110-1127	1
BOLT,GEAR CHANGE LEVER (Ref # 92001)	92001-1715	1
NUT,6MM (Ref # 92015)	92015-1443	1
NUT,LEFT HANDED,6MM (Ref # 92015A)	92015-1444	1
WASHER,13.2X20X0.5 (Ref # 92022)	92022-1224	1
SEAL-OIL,VB13193 (Ref # 92049)	92049-1398	2
DAMPER (Ref # 92075)	92075-1585	2
SPRING,CHANGE LEVER (Ref # 92081)	92081-1829	1
SPRING,CHANGE PEDAL RETURN (Ref # 92081A)	92081-1869	1
SPRING,LEVER (Ref # 92144)	92144-1850	1
BOLT,RETURN SPRING (Ref # 92150)	92150-1869	1
BOLT,6X20 (Ref # 92151)	92151-1226	1
BOLT,6X20 (Ref # 92151A)	92151-1450	1