

2001 Vulcan 800 Drifter PARTS DIAGRAM

Front Wheel

F2230

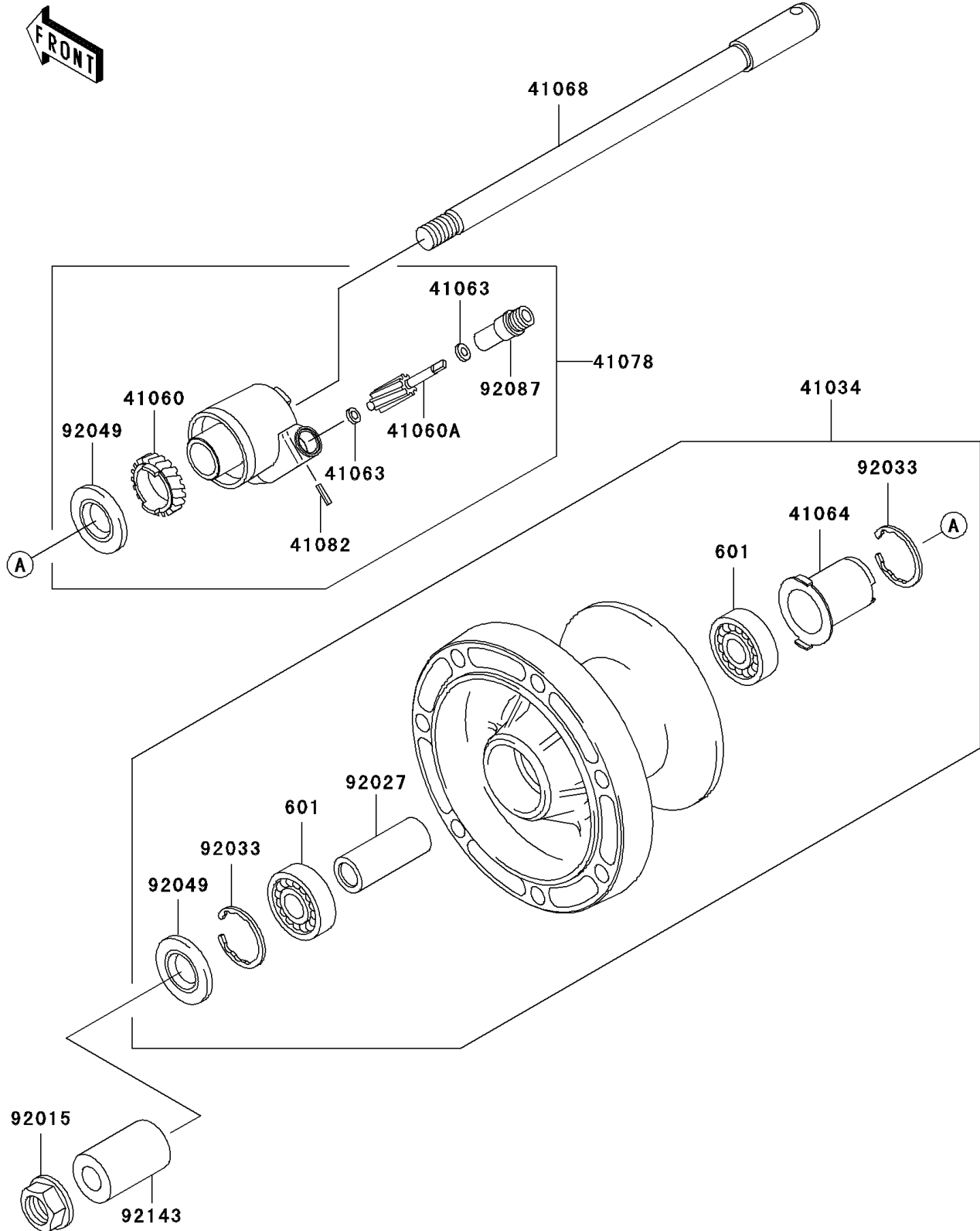

2001 Vulcan 800 Drifter PARTS LIST

Front Wheel

| ITEM NAME | PART NUMBER | QUANTITY |
|--|-------------|----------|
| BEARING-BALL,#6004UUC3 (Ref # 601) | 601B6004UU | 2 |
| DRUM-ASSY,FRONT BRAKE (Ref # 41034) | 41034-1293 | 1 |
| GEAR-METER SCREW,25T (Ref # 41060) | 41060-1160 | 1 |
| GEAR-METER SCREW,9T (Ref # 41060A) | 41060-1161 | 1 |
| WASHER,5.1X9X0.4 (Ref # 41063) | 41063-001 | 2 |
| RECEIVER-SPEEDOMETER (Ref # 41064) | 41064-1059 | 1 |
| AXLE,FR (Ref # 41068) | 41068-1378 | 1 |
| CASE-ASSY-METER GEAR (Ref # 41078) | 41078-1106 | 1 |
| PIN,SPRING (Ref # 41082) | 41082-001 | 1 |
| NUT,FLANGED,18MM (Ref # 92015) | 92015-1993 | 1 |
| COLLAR,20.2X28X70 (Ref # 92027) | 92027-1752 | 1 |
| RING-SNAP,42MM (Ref # 92033) | 92033-1041 | 2 |
| SEAL-OIL,BJN30427-C3 (Ref # 92049) | 92049-1057 | 2 |
| BUSHING-METER GEAR (Ref # 92087) | 92087-1056 | 1 |
| COLLAR,FR AXLE,LH,L=48.5 (Ref # 92143) | 92143-1837 | 1 |