

# 2001 Vulcan 800 Drifter PARTS DIAGRAM

Headlight(s)

F2710

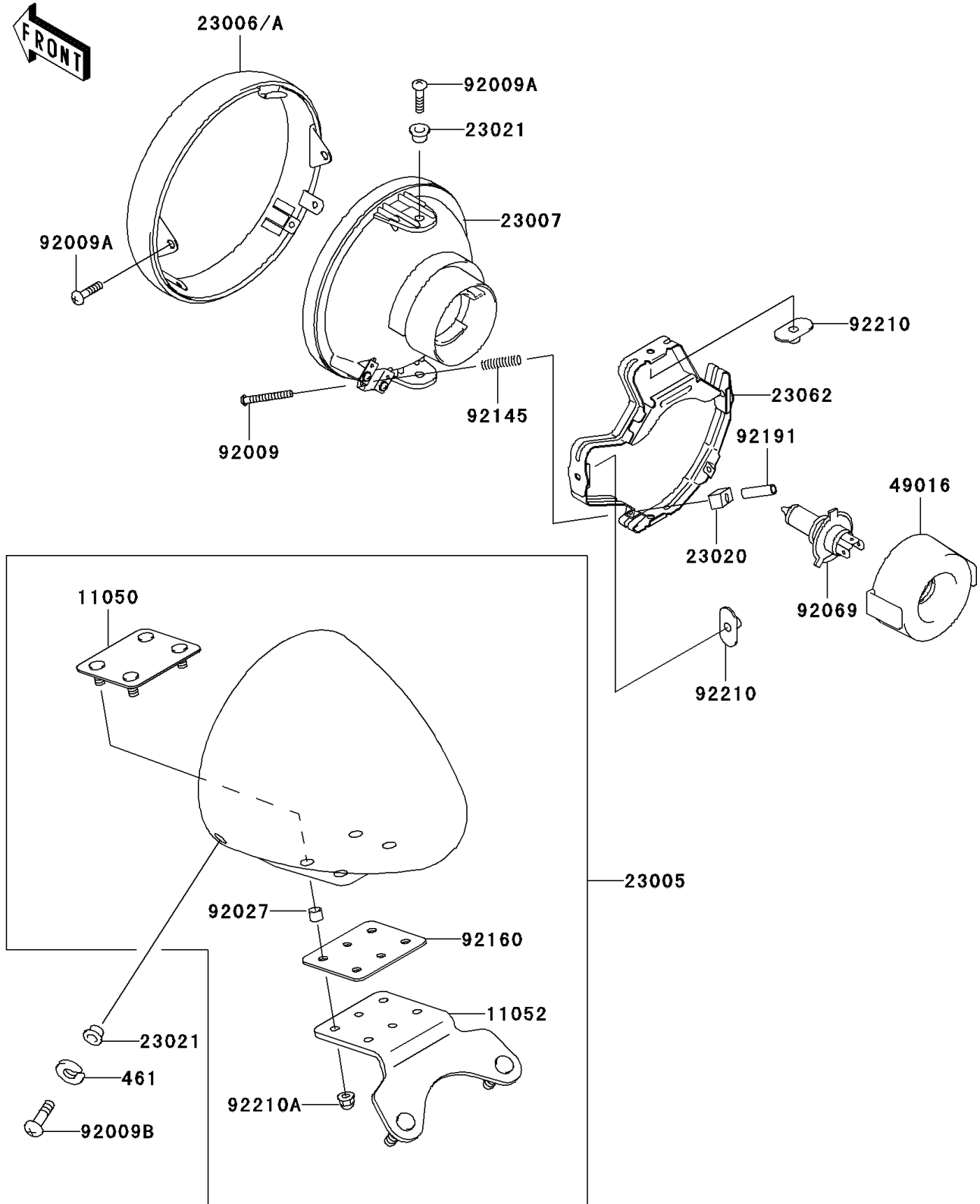

## 2001 Vulcan 800 Drifter PARTS LIST

### Headlight(s)

ITEM NAME	PART NUMBER	QUANTITY
WASHER-SPRING,5MM (Ref # 461)	461S0500	2
BRACKET,HEAD LAMP BODY (Ref # 11050)	11050-1978	1
BRACKET,HEAD LAMP BODY (Ref # 11052)	11052-1057	1
BODY-COMP-HEAD LAMP (Ref # 23005)	23005-1186	1
RIM-LAMP (Ref # 23006A)	23006-1079	1
LENS-COMP,HEAD LAMP (Ref # 23007)	23007-1359	1
NUT,4MM,FOCUS ADJUST (Ref # 23020)	23020-018	2
WASHER (Ref # 23021)	23021-010	4
BRACKET-COMP,HEAD LAMP (Ref # 23062)	23062-1131	1
COVER-SEAL,SOCKET (Ref # 49016)	49016-1203	1
SCREW,FOCUS ADJUST,4X60 (Ref # 92009)	92009-1816	2
SCREW,5X16 (Ref # 92009A)	92009-1879	4
SCREW,5MM (Ref # 92009B)	92009-1947	2
COLLAR,6.8X10X6 (Ref # 92027)	92027-103	4
BULB,12V 60/55W,H4 (Ref # 92069)	92069-1002	1
SPRING,HEAD LAMP LENS (Ref # 92145)	92145-1268	2
DAMPER (Ref # 92160)	92160-1960	1
TUBE,3.5X5.5X19 (Ref # 92191)	92191-1217	2
NUT,SPECIAL,5MM (Ref # 92210)	92210-1060	4
NUT (Ref # 92210A)	92210-1252	4