

2003 Vulcan 800 Drifter PARTS DIAGRAM

Accessory

F2910

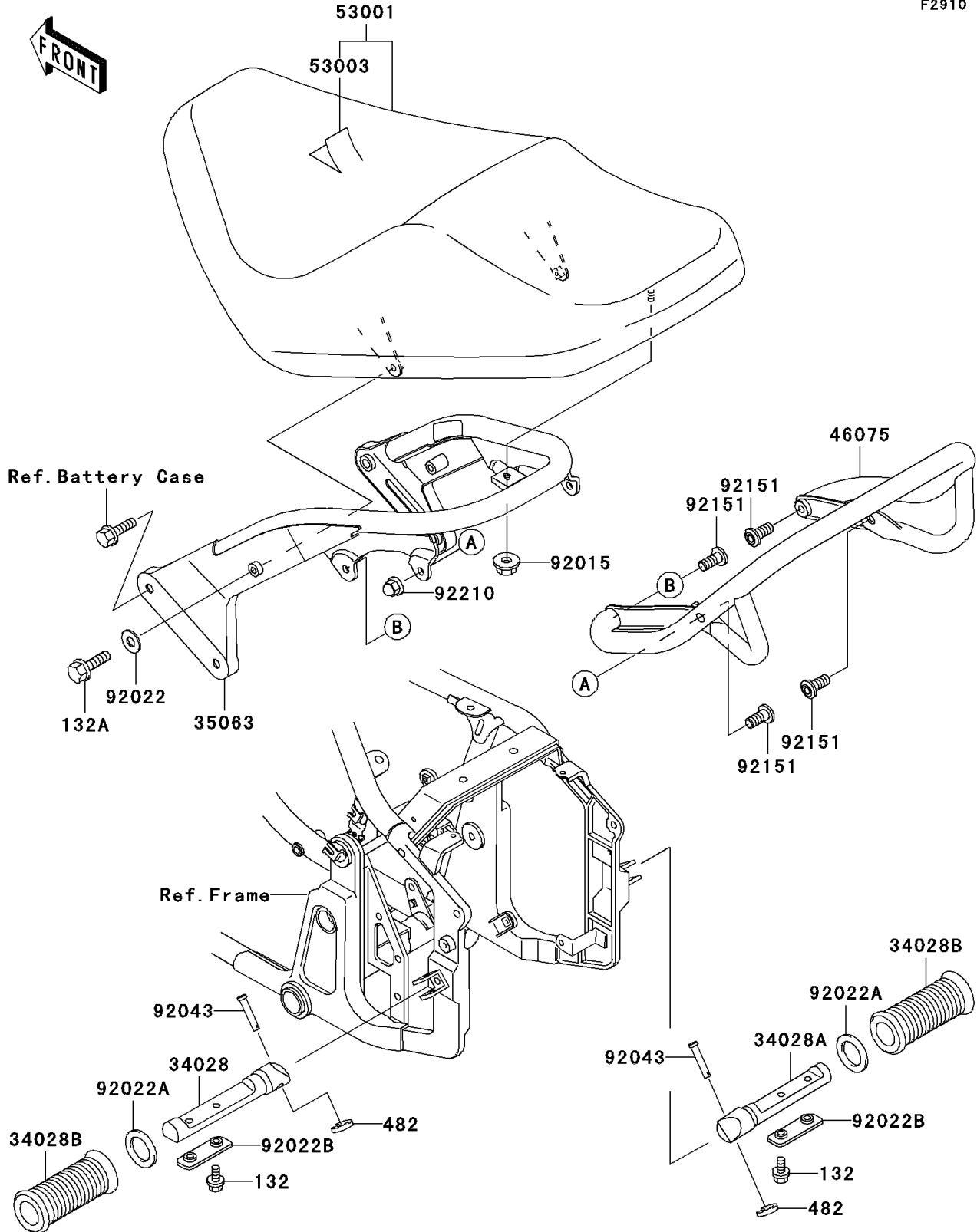

2003 Vulcan 800 Drifter PARTS LIST

Accessory

ITEM NAME	PART NUMBER	QUANTITY
BOLT-FLANGED-SMALL (Ref # 132)	132J0510	4
BOLT-FLANGED-SMALL (Ref # 132A)	132J0650	2
CIRCLIP-TYPE-E (Ref # 482)	482L7000	2
STEP,RR,LH (Ref # 34028)	34028-1219	1
STEP,RR,RH (Ref # 34028A)	34028-1220	1
STEP,RR,RUBBER (Ref # 34028B)	34028-1221	2
STAY,SEAT (Ref # 35063)	35063-1084	1
GRIP (Ref # 46075)	46075-1186	1
SEAT-ASSY,DUAL,BLACK (Ref # 53001)	53001-1898-MA	1
LEATHER,SEAT,BLACK (Ref # 53003)	53003-1432-MA	1
NUT,LOCK,FLANGED,6MM (Ref # 92015)	92015-1603	1
WASHER,7X16X1.2 (Ref # 92022)	92022-1344	2
WASHER,20X30X2.3 (Ref # 92022A)	92022-1568	2
WASHER,STEP (Ref # 92022B)	92022-1874	2
PIN,8X36.5 (Ref # 92043)	92043-1339	2
BOLT,SOCKET,10X22 (Ref # 92151)	92151-1577	4
NUT,CAP,10MM (Ref # 92210)	92210-1189	2