

2006 Vulcan 800 Drifter PARTS DIAGRAM

Gear Change Drum/Shift Fork(s)

E1362

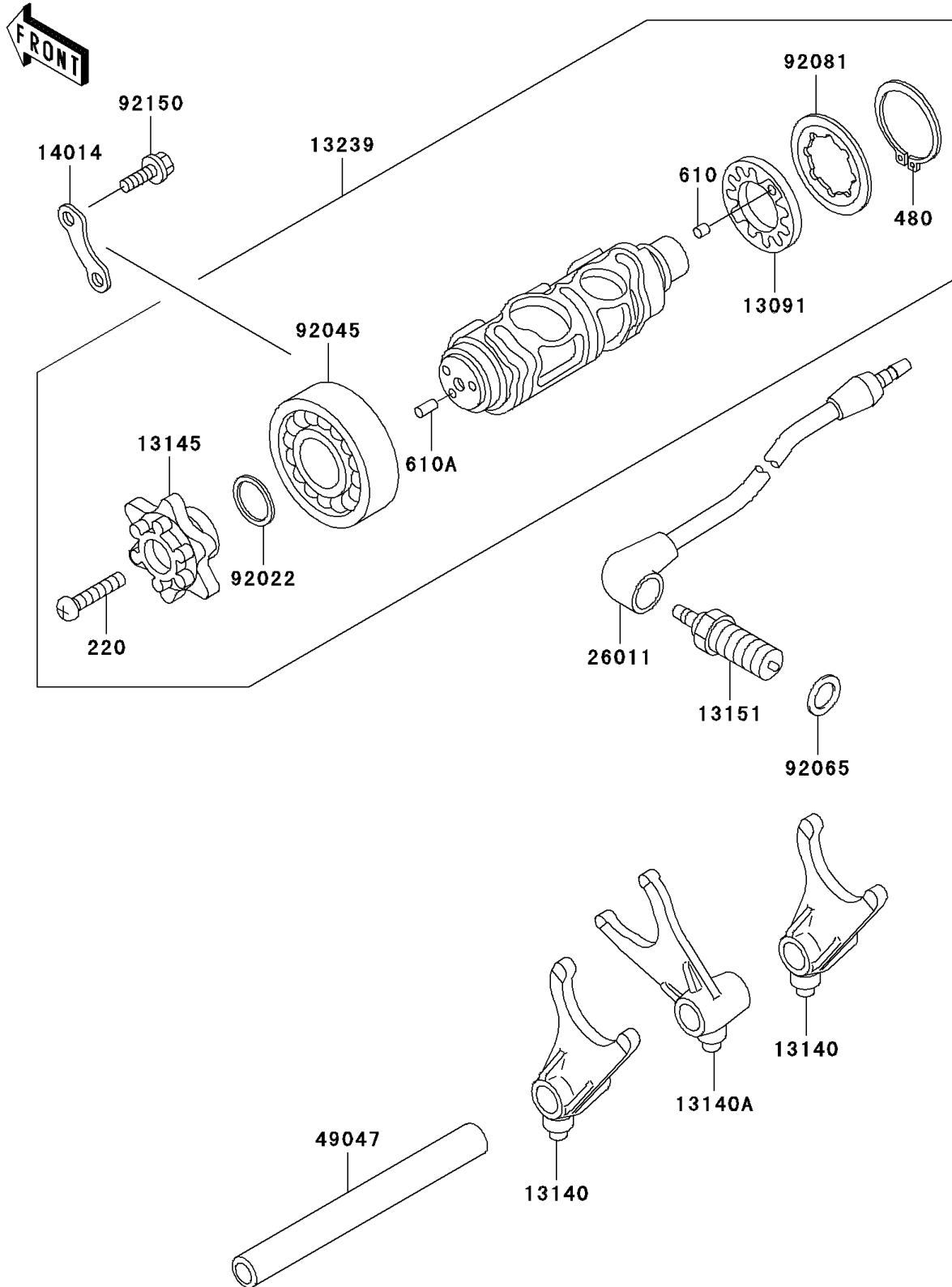

2006 Vulcan 800 Drifter PARTS LIST

Gear Change Drum/Shift Fork(s)

ITEM NAME	PART NUMBER	QUANTITY
SCREW-PAN-CROS,6X30 (Ref # 220)	220B0630	1
CIRCLIP-TYPE-C,22MM (Ref # 480)	480J2200	1
ROLLER,4X4 (Ref # 610)	610A0404	1
ROLLER,4X10 (Ref # 610A)	610A0410	1
HOLDER,CHANGE DRUM (Ref # 13091)	13091-1389	1
FORK-SHIFT (Ref # 13140)	13140-1126	2
FORK-SHIFT (Ref # 13140A)	13140-1138	1
CAM-CHANGE DRUM (Ref # 13145)	13145-1051	1
SWITCH-COMP (Ref # 13151)	13151-1085	1
DRUM-ASSY-CHANGE (Ref # 13239)	13239-1126	1
PLATE-POSITION (Ref # 14014)	14014-1014	1
WIRE-LEAD (Ref # 26011)	26011-1627	1
ROD-SHIFT (Ref # 49047)	49047-1059	1
WASHER,25.3X30X1 (Ref # 92022)	92022-161	1
BEARING-BALL,16005Z (Ref # 92045)	92045-1030	1
GASKET,10.5X16X1 (Ref # 92065)	92065-058	1
SPRING (Ref # 92081)	92081-1895	1
BOLT,6X12 (Ref # 92150)	92150-1868	2