

1987 Concours PARTS DIAGRAM

Breather Cover/Oil Pan

E1432-0035

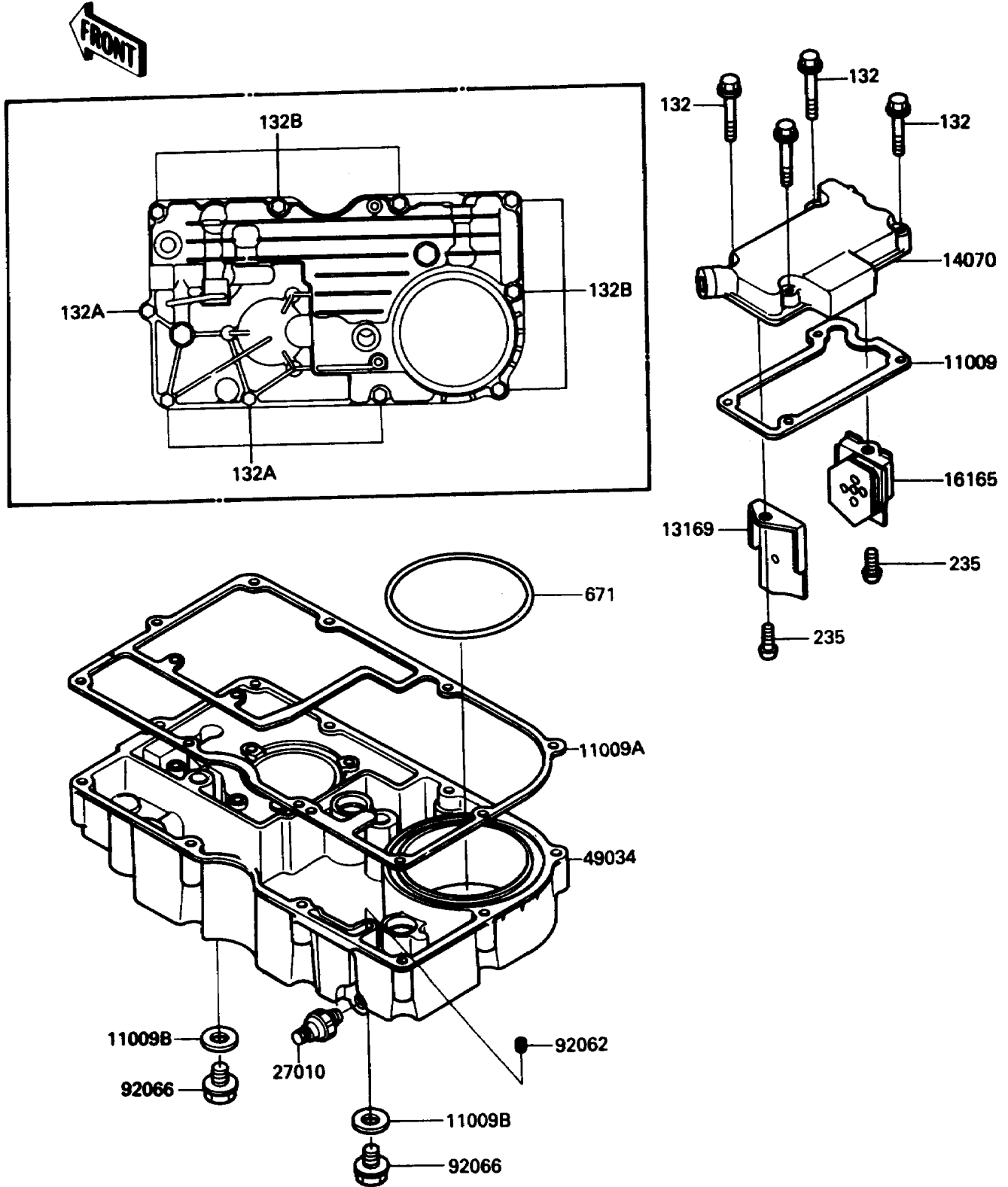

1987 Concours PARTS LIST

Breather Cover/Oil Pan

ITEM NAME	PART NUMBER	QUANTITY
GASKET,BREATHER BODY (Ref # 11009)	11009-1389	1
GASKET,OIL PAN (Ref # 11009A)	11009-1390	1
GASKET,12X22X2,DRAIN PLUG (Ref # 11009B)	92065-097	2
PLATE,BREATHER (Ref # 13169)	13169-1967	1
BODY-BREATHER (Ref # 14070)	14070-1061	1
SEPARATOR,OIL (Ref # 16165)	16165-1053	1
SWITCH,OIL PRESSURE (Ref # 27010)	27010-1155	1
PAN-OIL (Ref # 49034)	49034-1065	1
NOZZLE,YELLOW (Ref # 92062)	92062-1057	1
PLUG,OIL DRAIN,12X15 (Ref # 92066)	92066-1174	2
BOLT-FLANGED-SMALL (Ref # 132)	132E0625	4
BOLT-FLANGED-SMALL (Ref # 132A)	132W0625	4
BOLT-FLANGED-SMALL (Ref # 132B)	132W0640	6
SCREW-PAN-WP-CROS (Ref # 235)	235B0610	2
O RING,90MM (Ref # 671)	671B2590	1