

# 1988 Concours PARTS DIAGRAM

Front Bevel Gear

E3131-0014

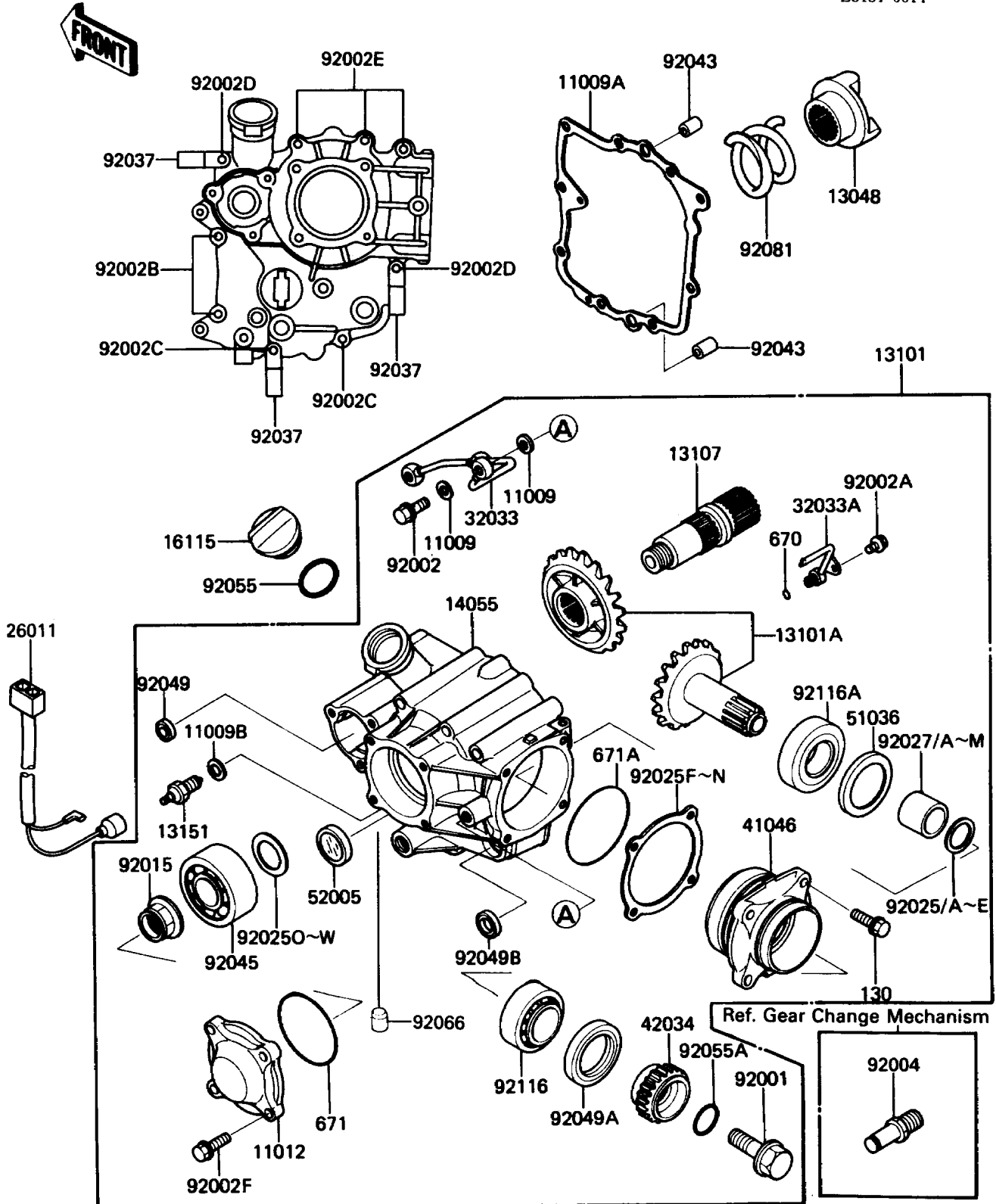

# 1988 Concours PARTS LIST

## Front Bevel Gear

ITEM NAME	PART NUMBER	QUANTITY
GASKET,OIL PIPE,8.2X14X1.0 (Ref # 11009)	11009-1344	6
GASKET,BEVEL GEAR CASE,FR (Ref # 11009A)	11009-1532	1
GASKET,10.5X16X1,DRAIN PLUG (Ref # 11009B)	92065-058	1
CAP,BEARING (Ref # 11012)	11012-1477	1
CAM-DAMPER (Ref # 13048)	13048-1069	1
GEAR-ASSY,FRONT BEVEL (Ref # 13101)	13101-1097	1
GEAR-ASSY,FRONT BEVEL (Ref # 13101A)	13101-5062	1
SHAFT,BEVEL GEAR,FR (Ref # 13107)	13107-1190	1
SWITCH-COMP,NEUTRAL (Ref # 13151)	13151-1007	1
CASE-GEAR,BEVEL,FR (Ref # 14055)	14055-1065	1
CAP-OIL FILLER (Ref # 16115)	16115-1009	1
WIRE-LEAD (Ref # 26011)	26011-1351	1
PIPE,OIL (Ref # 32033)	32033-1706	1
PIPE,OIL (Ref # 32033A)	32033-1707	1
HOUSING-BEARING (Ref # 41046)	41046-1067	1
COUPLING,FR DRIVEN (Ref # 42034)	42034-1014	1
CUP (Ref # 51036)	51036-1002	1
GAUGE,OIL LEVEL (Ref # 52005)	52005-1057	1
BOLT,FLANGED,12X42 (Ref # 92001)	92001-1169	1
BOLT,BANJO,8X20 (Ref # 92002)	92002-1429	3
BOLT,6X10 (Ref # 92002A)	92002-1449	1
BOLT,6X25 (Ref # 92002B)	92002-1582	2
BOLT,6X50 (Ref # 92002C)	92002-1583	2
BOLT,6X60 (Ref # 92002D)	92002-1584	2
BOLT,6X105 (Ref # 92002E)	92002-1585	3
BOLT,6X25 (Ref # 92002F)	92002-1612	4
STUD (Ref # 92004)	92004-1109	1
NUT (Ref # 92015)	92015-1543	1
SHIM,25.2X29.8X1.70 (Ref # 92025)	92025-1072	AR

# 1988 Concours PARTS LIST

## Front Bevel Gear

ITEM NAME	PART NUMBER	QUANTITY
SHIM,25.2X29.8X1.72 (Ref # 92025A)	92025-1073	AR
SHIM,25.2X29.8X1.74 (Ref # 92025B)	92025-1074	AR
SHIM,25.2X29.8X1.76 (Ref # 92025C)	92025-1075	AR
SHIM,25.2X29.8X1.78 (Ref # 92025D)	92025-1076	AR
SHIM,25.2X29.8X1.80 (Ref # 92025E)	92025-1077	AR
SHIM,T=0.10 (Ref # 92025F)	92025-1606	AR
SHIM,T=0.15 (Ref # 92025G)	92025-1607	AR
SHIM,T=0.50 (Ref # 92025H)	92025-1608	AR
SHIM,T=0.60 (Ref # 92025I)	92025-1609	AR
SHIM,T=0.70 (Ref # 92025J)	92025-1610	AR
SHIM,T=0.80 (Ref # 92025K)	92025-1611	AR
SHIM,T=0.90 (Ref # 92025L)	92025-1612	AR
SHIM,T=1.00 (Ref # 92025M)	92025-1613	AR
SHIM,T=1.20 (Ref # 92025N)	92025-1614	AR
SHIM,25.3X36X0.15 (Ref # 92025O)	92025-1688	AR
SHIM,25.3X36X0.50 (Ref # 92025P)	92025-1689	AR
SHIM,25.3X36X0.60 (Ref # 92025Q)	92025-1690	AR
SHIM,25.3X36X0.70 (Ref # 92025R)	92025-1691	AR
SHIM,25.3X36X0.80 (Ref # 92025S)	92025-1692	AR
SHIM,25.3X36X0.90 (Ref # 92025T)	92025-1693	AR
SHIM,25.3X36X1.00 (Ref # 92025U)	92025-1694	AR
SHIM,25.3X36X1.10 (Ref # 92025V)	92025-1695	AR
SHIM,25.3X36X1.20 (Ref # 92025W)	92025-1696	AR
COLLAR,25.2X29.8X22.8 (Ref # 92027)	92027-1152	AR
COLLAR,25.2X29.8X22.9 (Ref # 92027A)	92027-1153	AR
COLLAR,25.2X29.8X23 (Ref # 92027B)	92027-1154	AR
COLLAR,25.2X29.8X23.1 (Ref # 92027C)	92027-1155	AR
COLLAR,25.2X29.8X23.2 (Ref # 92027D)	92027-1156	AR
COLLAR,25.2X29.8X23.3 (Ref # 92027E)	92027-1157	AR

# 1988 Concours PARTS LIST

## Front Bevel Gear

ITEM NAME	PART NUMBER	QUANTITY
COLLAR,25.2X29.8X23.4 (Ref # 92027F)	92027-1158	AR
COLLAR,25.2X29.8X23.5 (Ref # 92027G)	92027-1159	AR
COLLAR,25.2X29.8X23.6 (Ref # 92027H)	92027-1160	AR
COLLAR,25.2X29.8X23.7 (Ref # 92027I)	92027-1161	AR
COLLAR,25.2X29.8X23.8 (Ref # 92027J)	92027-1162	AR
COLLAR,25.2X29.8X23.9 (Ref # 92027K)	92027-1163	AR
COLLAR,25.2X29.8X24 (Ref # 92027L)	92027-1164	AR
COLLAR,25.2X29.8X24.1 (Ref # 92027M)	92027-1165	AR
CLAMP,WIRING HARNESS (Ref # 92037)	92037-1539	3
PIN,DOWEL,6.3X8X14 (Ref # 92043)	92042-007	2
BEARING-BALL (Ref # 92045)	92045-1160	1
SEAL-OIL,SD-8187 (Ref # 92049)	92049-1017	1
SEAL-OIL,TC35527 (Ref # 92049A)	92049-1038	1
SEAL-OIL,TB13225.5 (Ref # 92049B)	92051-005	1
RING-O,31.5X2.6 (Ref # 92055)	92055-049	1
RING-O,ID=18.64 (Ref # 92055A)	92055-1044	1
PLUG,OIL LINE,7.2X8 (Ref # 92066)	92066-1012	1
SPRING,CAM DAMPER (Ref # 92081)	92081-1859	1
BEARING-ROLLER,4T30205 (Ref # 92116)	92116-1003	1
BEARING-ROLLER,4T30305 (Ref # 92116A)	92116-1006	1
BOLT-FLANGED,6X25,BLACK (Ref # 130)	130S0625	4
O RING,6MM (Ref # 670)	670B1506	1
O RING,65MM (Ref # 671)	671B2565	1
O RING,70MM (Ref # 671A)	671B2570	1