

1988 Concours PARTS DIAGRAM

Footrests

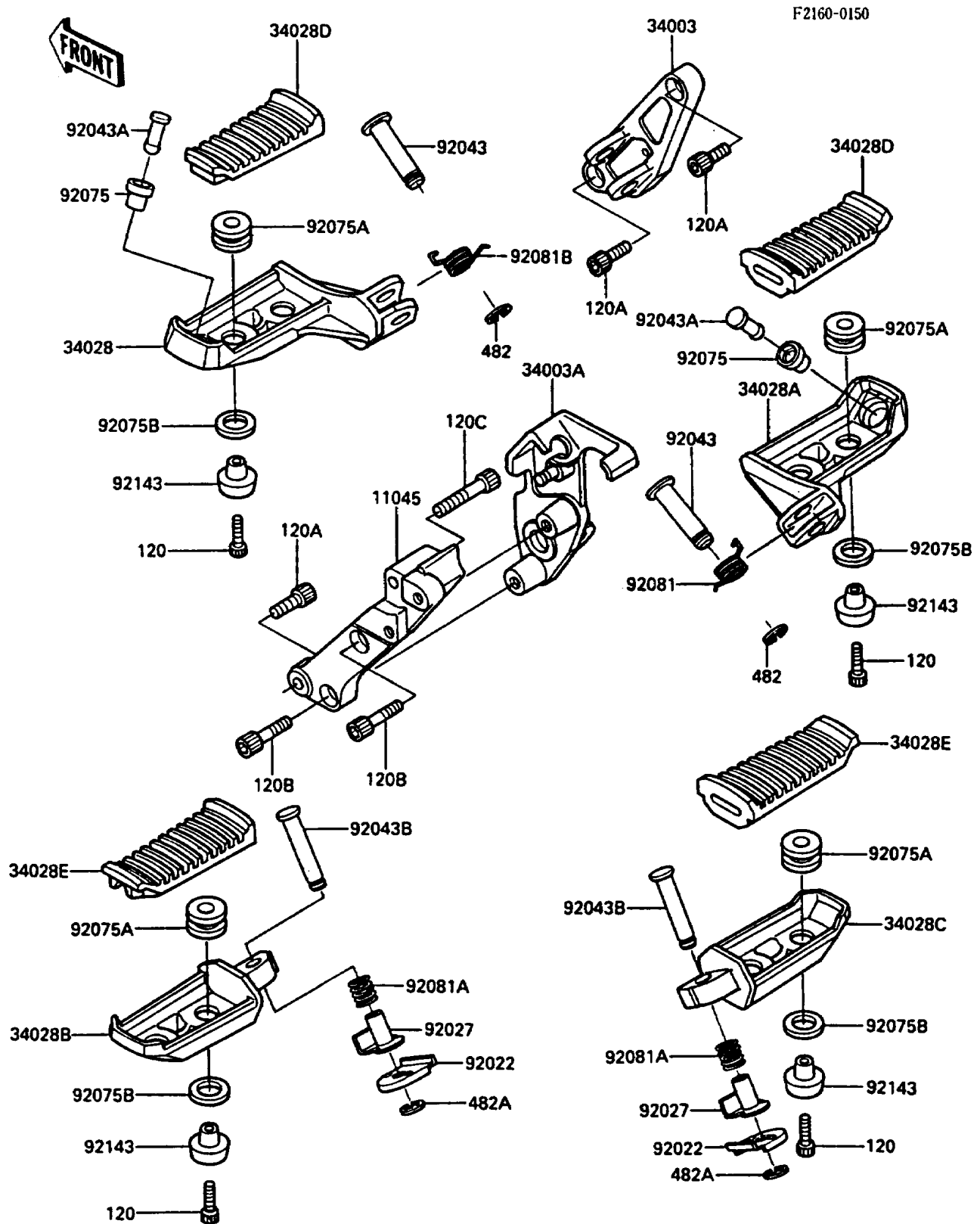

1988 Concours PARTS LIST

Footrests

ITEM NAME	PART NUMBER	QUANTITY
BRACKET,FRONT STEP,RH (Ref # 11045)	11044-1911	1
HOLDER-STEP,FR,LH (Ref # 34003)	34003-1259	1
HOLDER-STEP,FR,RH (Ref # 34003A)	34003-1260	1
STEP,FR,LH (Ref # 34028)	34028-1198	1
STEP,FR,RH (Ref # 34028A)	34028-1199	1
STEP,RR,LH (Ref # 34028B)	34028-1200	1
STEP,RR,RH (Ref # 34028C)	34028-1201	1
STEP,FR,RUBBER (Ref # 34028D)	34028-1206	2
STEP,RR,RUBBER (Ref # 34028E)	34028-1207	2
WASHER,STEP,RR (Ref # 92022)	92022-1507	2
COLLAR,STEP (Ref # 92027)	92027-1732	2
PIN,12X42.5 (Ref # 92043)	92043-1145	2
PIN,BANK SENSOR (Ref # 92043A)	92043-1219	2
PIN,6X38.5 (Ref # 92043B)	92043-1238	2
DAMPER,BANK SENSOR (Ref # 92075)	92075-1597	2
DAMPER,MALE (Ref # 92075A)	92075-174	8
DAMPER,FEMALE (Ref # 92075B)	92075-175	8
SPRING,STEP RETURN,RH (Ref # 92081)	92081-1587	1
SPRING,STEP,RR (Ref # 92081A)	92081-1612	2
SPRING,STEP RETURN,LH (Ref # 92081B)	92081-1733	1
COLLAR,STEP (Ref # 92143)	92143-1005	8
BOLT-SOCKET (Ref # 120)	120P0520	8
BOLT-SOCKET,8X20 (Ref # 120A)	120P0820	3
BOLT-SOCKET,8X25 (Ref # 120B)	120P0825	2
BOLT-SOCKET,8X40 (Ref # 120C)	120P0840	1
CIRCLIP-TYPE-E,10MM (Ref # 482)	482L0100	2
CIRCLIP-TYPE-E,5MM (Ref # 482A)	482L5000	2