

# 2013 KLX® 250S PARTS DIAGRAM

Camshaft(s)/Tensioner

E1230

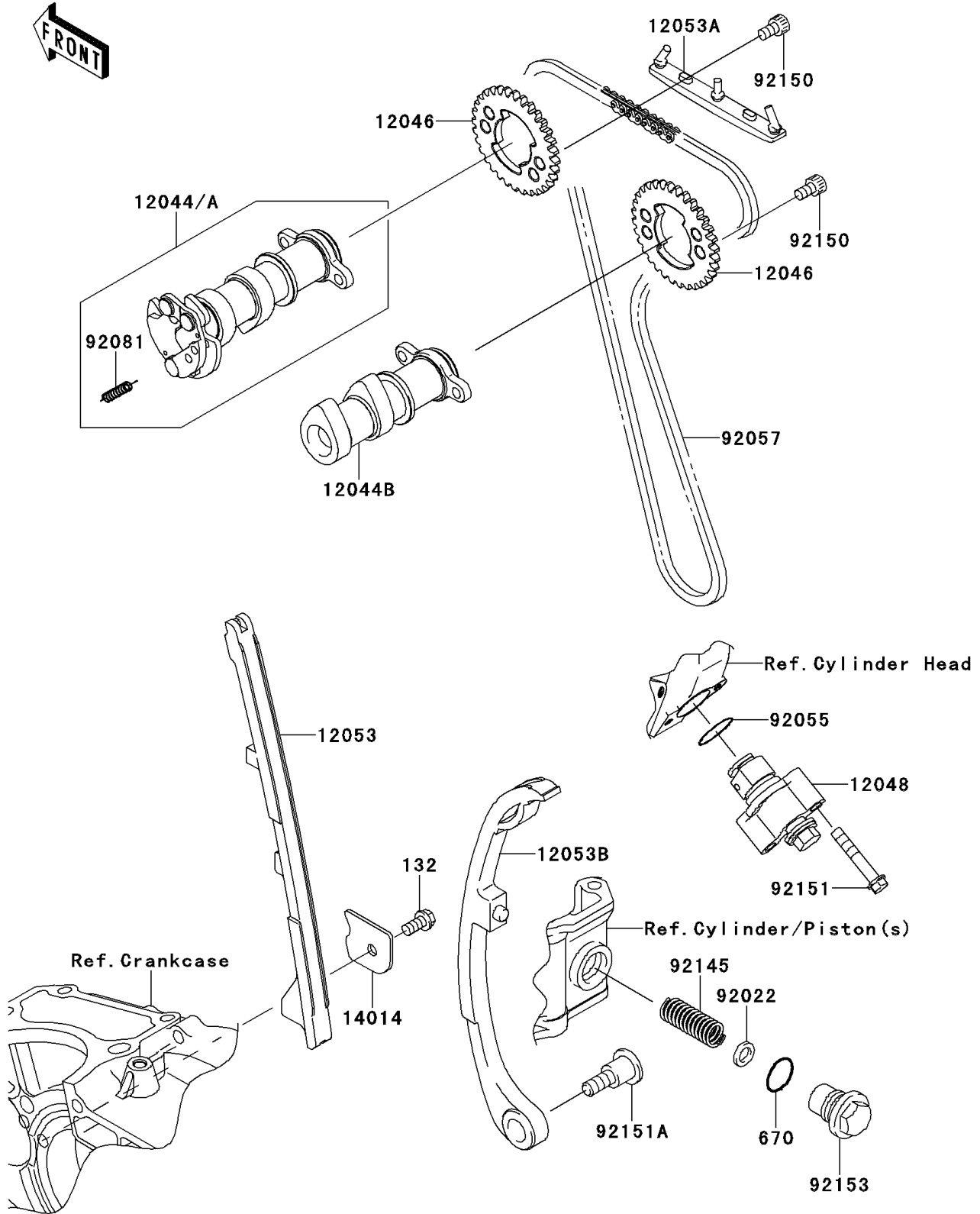

## 2013 KLX® 250S PARTS LIST

### Camshaft(s)/Tensioner

ITEM NAME	PART NUMBER	QUANTITY
BOLT-FLANGED-SMALL,6X12 (Ref # 132)	132BB0612	1
O RING,18MM (Ref # 670)	670B2018	1
CAMSHAFT-VALVE,EXHAUST (Ref # 12044A)	12044-0746	1
CAMSHAFT-VALVE,INTAKE (Ref # 12044B)	12044-1327	1
SPROCKET,CAMSHAFT,32T (Ref # 12046)	12046-0001	2
TENSIONER-ASSY (Ref # 12048)	12048-0054	1
GUIDE-CHAIN,FR (Ref # 12053)	12053-1315	1
GUIDE-CHAIN,UPP (Ref # 12053A)	12053-1317	1
GUIDE-CHAIN,RR (Ref # 12053B)	12053-1391	1
PLATE-POSITION (Ref # 14014)	14014-1130	1
WASHER,8.5X13.5X2 (Ref # 92022)	92022-1108	1
RING-O,18.8X1.9 (Ref # 92055)	92055-086	1
CHAIN,CAM,92RH2010 (Ref # 92057)	92057-1416	1
SPRING,DECOMPRESSOR (Ref # 92081)	92081-1626	1
SPRING,TENSIONER (Ref # 92145)	92145-0367	1
BOLT,SOCKET,6X10 (Ref # 92150)	92150-1650	4
BOLT,6X35 (Ref # 92151)	92151-1135	2
BOLT,L=30 (Ref # 92151A)	92151-1154	1
BOLT,TENSIONER (Ref # 92153)	92153-0650	1