

# 2012 KLX<sup>®</sup>250S PARTS DIAGRAM

## Crankcase

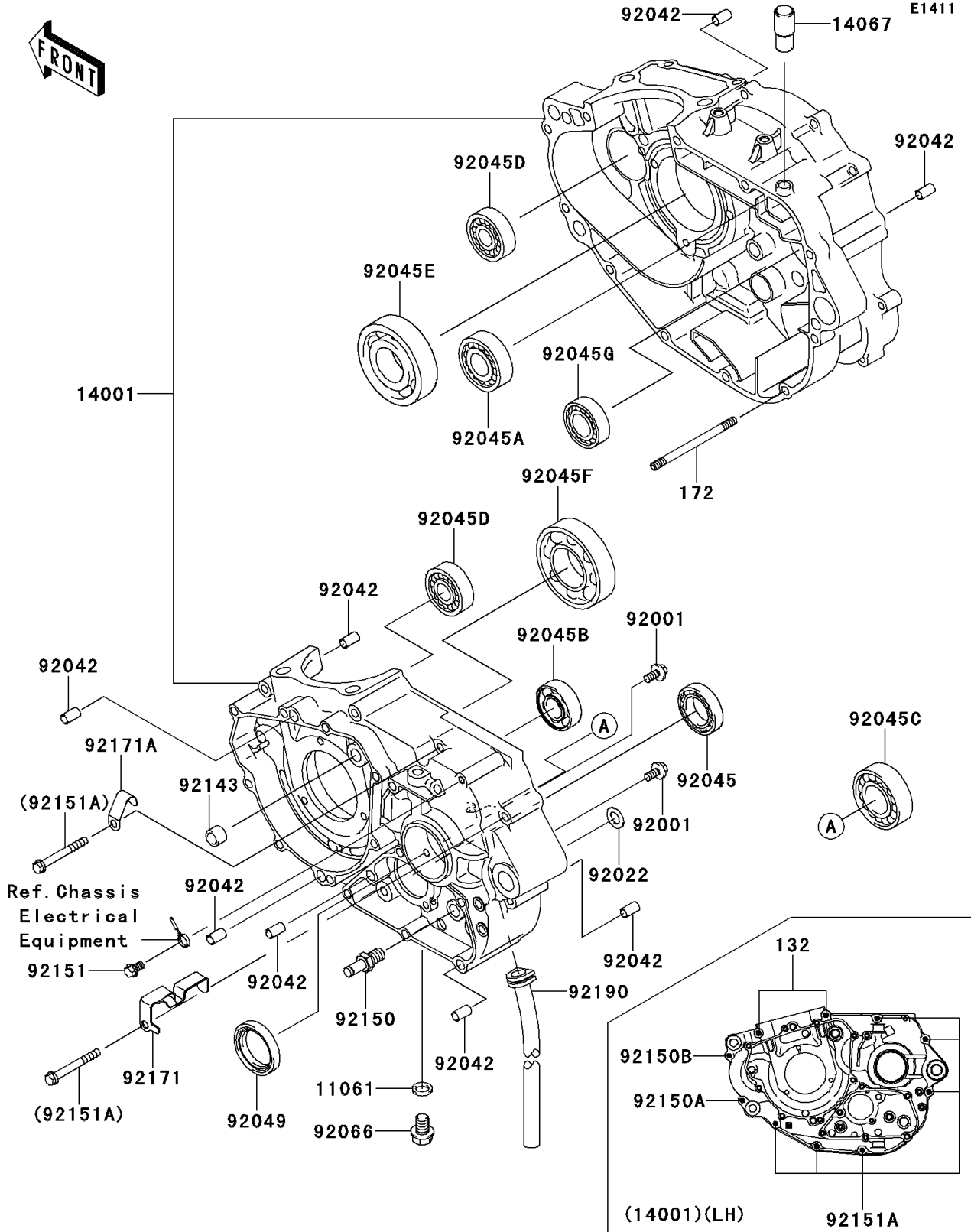

## 2012 KLX® 250S PARTS LIST

### Crankcase

ITEM NAME	PART NUMBER	QUANTITY
BOLT-FLANGED-SMALL,6X70 (Ref # 132)	132BC0670	2
BOLT-STUD,6X80 (Ref # 172)	172BA0680	1
GASKET,10.5X16X2 (Ref # 11061)	11061-0222	1
SET-CRANKCASE (Ref # 14001)	14001-0138	1
FITTING,BREATHER (Ref # 14067)	14067-006	1
BOLT,W/WASHER,6X14 (Ref # 92001)	92001-1829	2
WASHER,10.2X18X1.0,SK5 (Ref # 92022)	92022-1415	1
PIN,DOWEL,6.3X8X14 (Ref # 92042)	92042-007	8
BEARING-BALL,#6905 (Ref # 92045)	92045-036	1
BEARING-BALL,TMB204 JR (Ref # 92045A)	92045-1041	1
BEARING-BALL,TMB203LU (Ref # 92045B)	92045-1287	1
BEARING-BALL,TMB205LU (Ref # 92045C)	92045-1288	1
BEARING-BALL,TMB302JR2 (Ref # 92045D)	92045-1346	2
BEARING-BALL,TMB306JR2 (Ref # 92045E)	92045-1347	1
BEARING-BALL,3TM-6207CJR2 (Ref # 92045F)	92045-1348	1
BEARING-BALL,DG204012 (Ref # 92045G)	92045-1414	1
SEAL-OIL,TC32457 (Ref # 92049)	92049-1577	1
PLUG,DRAIN (Ref # 92066)	92066-0143	1
COLLAR (Ref # 92143)	92143-1263	1
BOLT,RETURN SPRING (Ref # 92150)	92150-1803	1
BOLT,SOCKET,6X50 (Ref # 92150A)	92150-1874	1
BOLT,SOCKET,6X35 (Ref # 92150B)	92150-1875	1
BOLT,FLANGED,6X10 (Ref # 92151)	92151-1233	1
BOLT,6X50 (Ref # 92151A)	92151-1234	6
CLAMP (Ref # 92171)	92171-1823	1
CLAMP (Ref # 92171A)	92171-1918	1
TUBE (Ref # 92190)	92190-1493	1