

2009 KLX® 250S PARTS DIAGRAM

Oil Pump

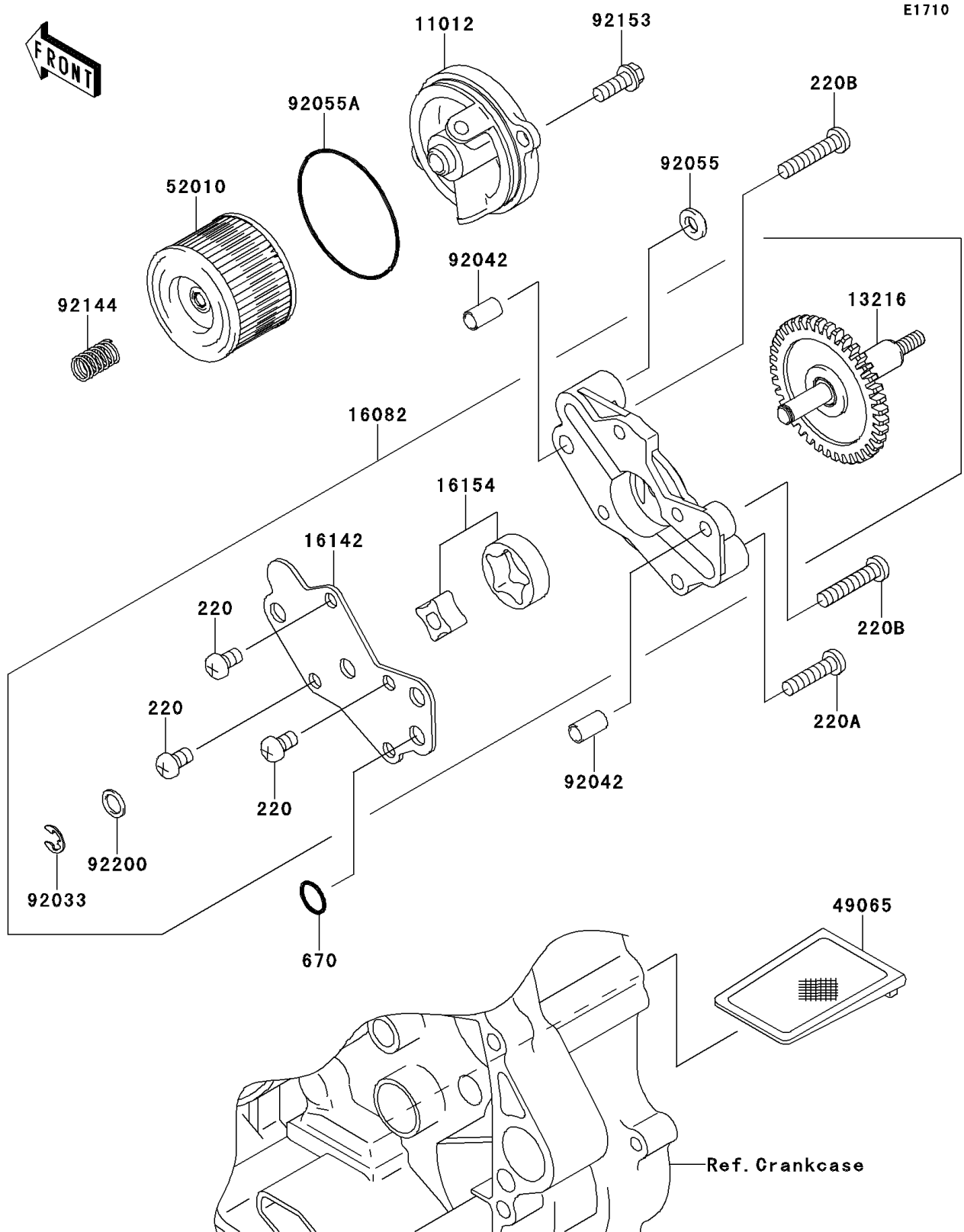

2009 KLX® 250S PARTS LIST

Oil Pump

ITEM NAME	PART NUMBER	QUANTITY
SCREW-PAN-CROS,6X10 (Ref # 220)	220AA0610	3
SCREW-PAN-CROS,6X25 (Ref # 220A)	220AA0625	1
SCREW-PAN-CROS,6X30 (Ref # 220B)	220AA0630	2
O RING (Ref # 670)	670D2010	1
CAP,OIL FILTER (Ref # 11012)	11012-1915	1
GEAR-COMP,OIL PUMP (Ref # 13216)	13216-1193	1
PUMP-ASSY-OIL (Ref # 16082)	16082-1163	1
COVER-PUMP (Ref # 16142)	16142-1123	1
ROTOR-PUMP (Ref # 16154)	16154-1130	1
FILTER-OIL (Ref # 49065)	49065-1058	1
ELEMENT-OIL FILTER (Ref # 52010)	52010-1053	1
RING-SNAP,6MM (Ref # 92033)	92033-1327	1
PIN,DOWEL,6.3X8X14 (Ref # 92042)	92042-007	2
RING-O,OD=13 (Ref # 92055)	92055-074	1
RING-O,52.6X2.4 (Ref # 92055A)	92055-1577	1
SPRING (Ref # 92144)	92144-1761	1
BOLT,6X16 (Ref # 92153)	92153-0695	2
WASHER,8.5X12X1.0 (Ref # 92200)	92200-1591	1