

1991 Concours PARTS DIAGRAM

Head Lamp

F 2710

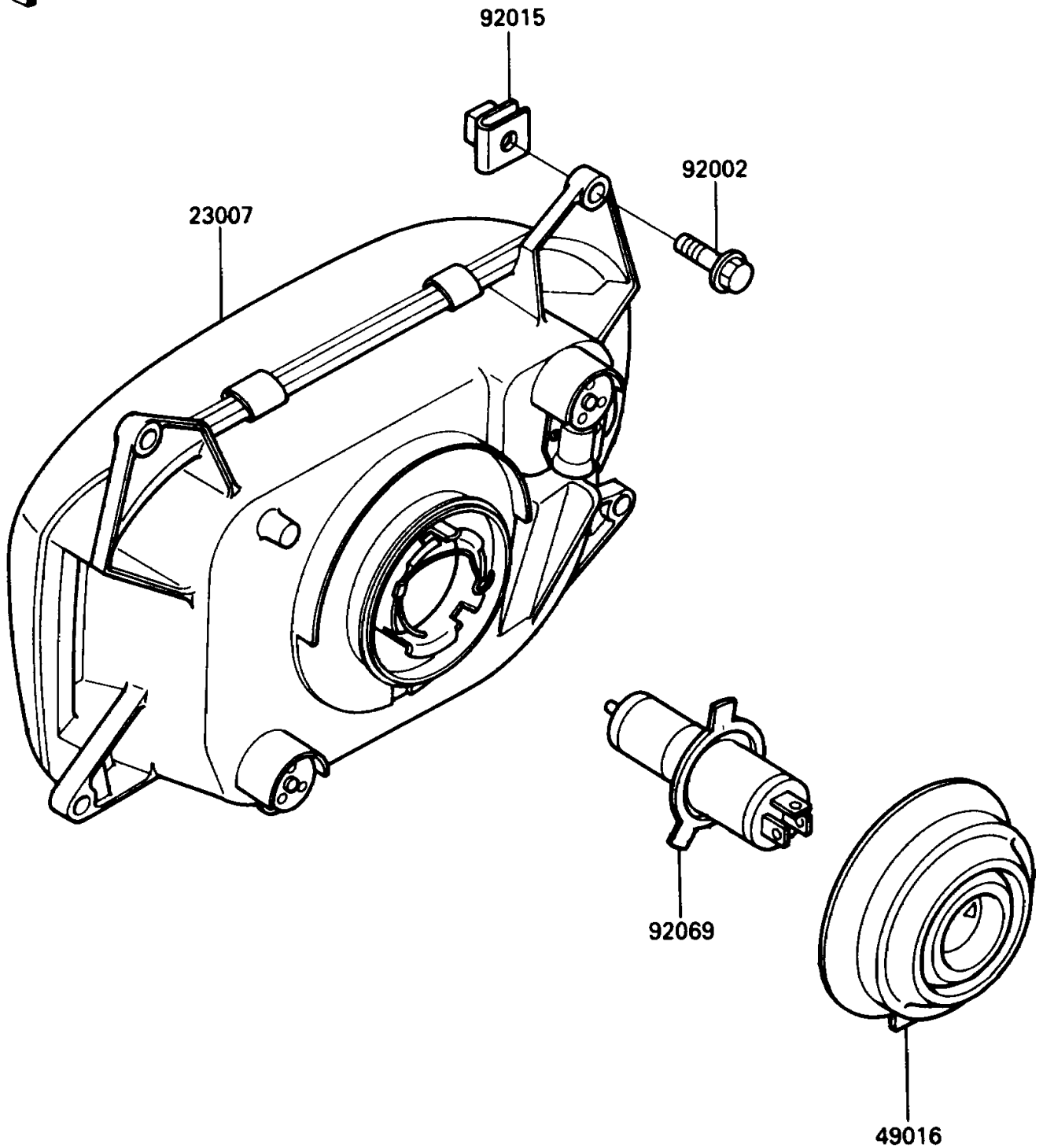

1991 Concours PARTS LIST

Head Lamp

ITEM NAME	PART NUMBER	QUANTITY
LENS-COMP,HEAD LAMP (Ref # 23007)	23007-1132	1
COVER-SEAL,HEAD LAMP (Ref # 49016)	49016-1108	1
BOLT,6X25 (Ref # 92002)	92002-1135	4
NUT,6MM (Ref # 92015)	92015-1094	4
BULB,12V 60/55W,H4 (Ref # 92069)	92069-1002	1