

1993 Concours PARTS DIAGRAM

Camshaft(s)/Tensioner

E1230

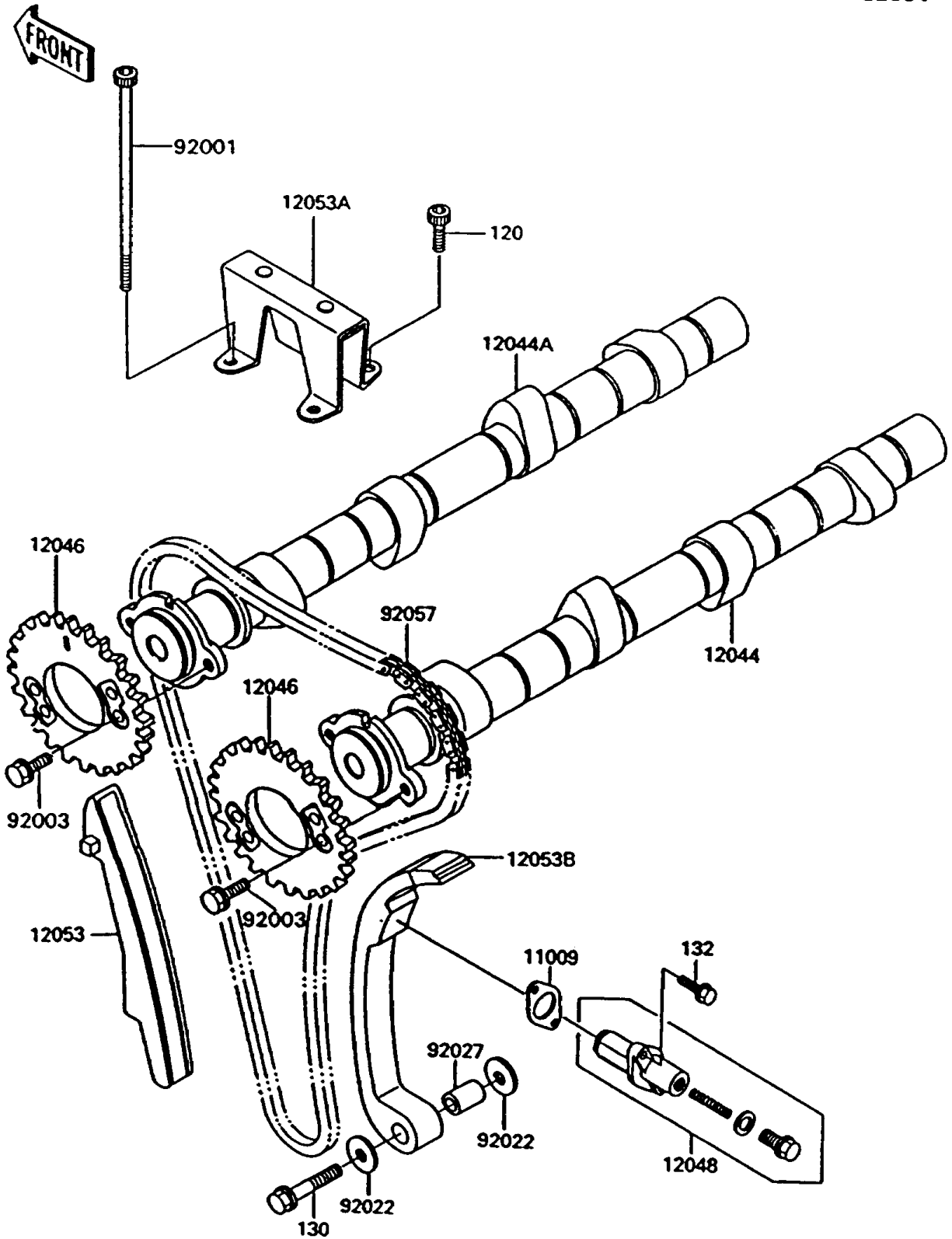

1993 Concours PARTS LIST

Camshaft(s)/Tensioner

ITEM NAME	PART NUMBER	QUANTITY
GASKET,TENSIONER (Ref # 11009)	11009-1858	1
CAMSHAFT-VALVE,INTAKE (Ref # 12044)	12044-1151	1
CAMSHAFT-VALVE,EXHAUST (Ref # 12044A)	12044-1152	1
SPROCKET,CAMSHAFT,34T (Ref # 12046)	12046-1082	2
TENSIONER-ASSY (Ref # 12048)	12048-1113	1
GUIDE-CHAIN,FR (Ref # 12053)	12053-1114	1
GUIDE-CHAIN,UPP (Ref # 12053A)	12053-1115	1
GUIDE-CHAIN,RR (Ref # 12053B)	12053-1239	1
BOLT,6X118 (Ref # 92001)	92001-1904	2
BOLT,FLANGED,6X11 (Ref # 92003)	92003-208	4
WASHER,8.2X19X2 (Ref # 92022)	92022-1533	2
COLLAR,8.2X10.5X15.6 (Ref # 92027)	92027-1763	1
CHAIN,CAMSHAFT (Ref # 92057)	92057-1160	1
BOLT-SOCKET,6X14 (Ref # 120)	120P0614	2
BOLT-FLANGED,8X35 (Ref # 130)	130G0835	1
BOLT-FLANGED-SMALL (Ref # 132)	132J0625	2