

1994 Concours PARTS DIAGRAM

Engine Cover(s)

E1431

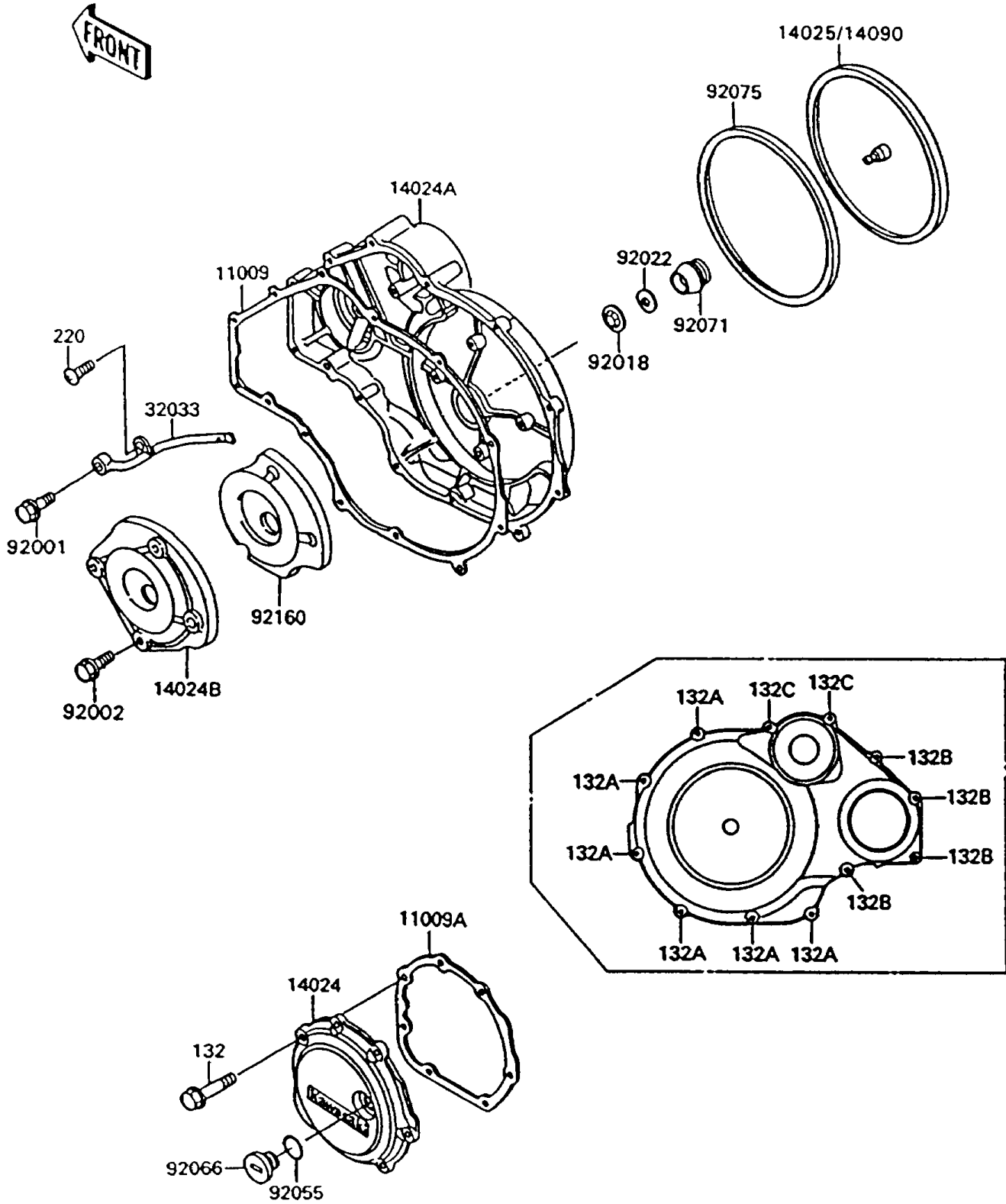

1994 Concours PARTS LIST

Engine Cover(s)

ITEM NAME	PART NUMBER	QUANTITY
GASKET,CLUTCH COVER (Ref # 11009)	11009-1860	1
GASKET,COVER,LH (Ref # 11009A)	11009-1863	1
COVER,LH (Ref # 14024)	14024-1066	1
COVER,CLUTCH (Ref # 14024A)	14024-1067	1
COVER,SOUND ARRESTER (Ref # 14024B)	14024-1925	1
COVER,CLUTCH COVER (Ref # 14090)	14090-1409	1
PIPE,CLUTCH COVER (Ref # 32033)	32033-1204	1
BOLT,BANJO,8X20 (Ref # 92001)	92001-1855	1
BOLT,6X10 (Ref # 92002)	92002-1541	4
NUT,LOCK,5MM (Ref # 92018)	92018-004	1
WASHER,5.5X20X1.2 (Ref # 92022)	92022-104	1
RING-O (Ref # 92055)	92055-1146	1
PLUG,COVER,LH (Ref # 92066)	92066-1218	1
GROMMET,CLUTCH COVER (Ref # 92071)	92071-1108	1
DAMPER,CLUTCH COVER (Ref # 92075)	92075-1594	1
DAMPER,SOUND ARRESTER (Ref # 92160)	92160-1209	1
BOLT-FLANGED-SMALL (Ref # 132)	132J0620	7
BOLT-FLANGED-SMALL (Ref # 132A)	132J0625	6
BOLT-FLANGED-SMALL,6X40 (Ref # 132B)	132J0640	4
BOLT-FLANGED-SMALL,6X55 (Ref # 132C)	132J0655	2
SCREW-PAN-CROS (Ref # 220)	220B0510	1