

1994 Concours PARTS DIAGRAM

Frame Fittings

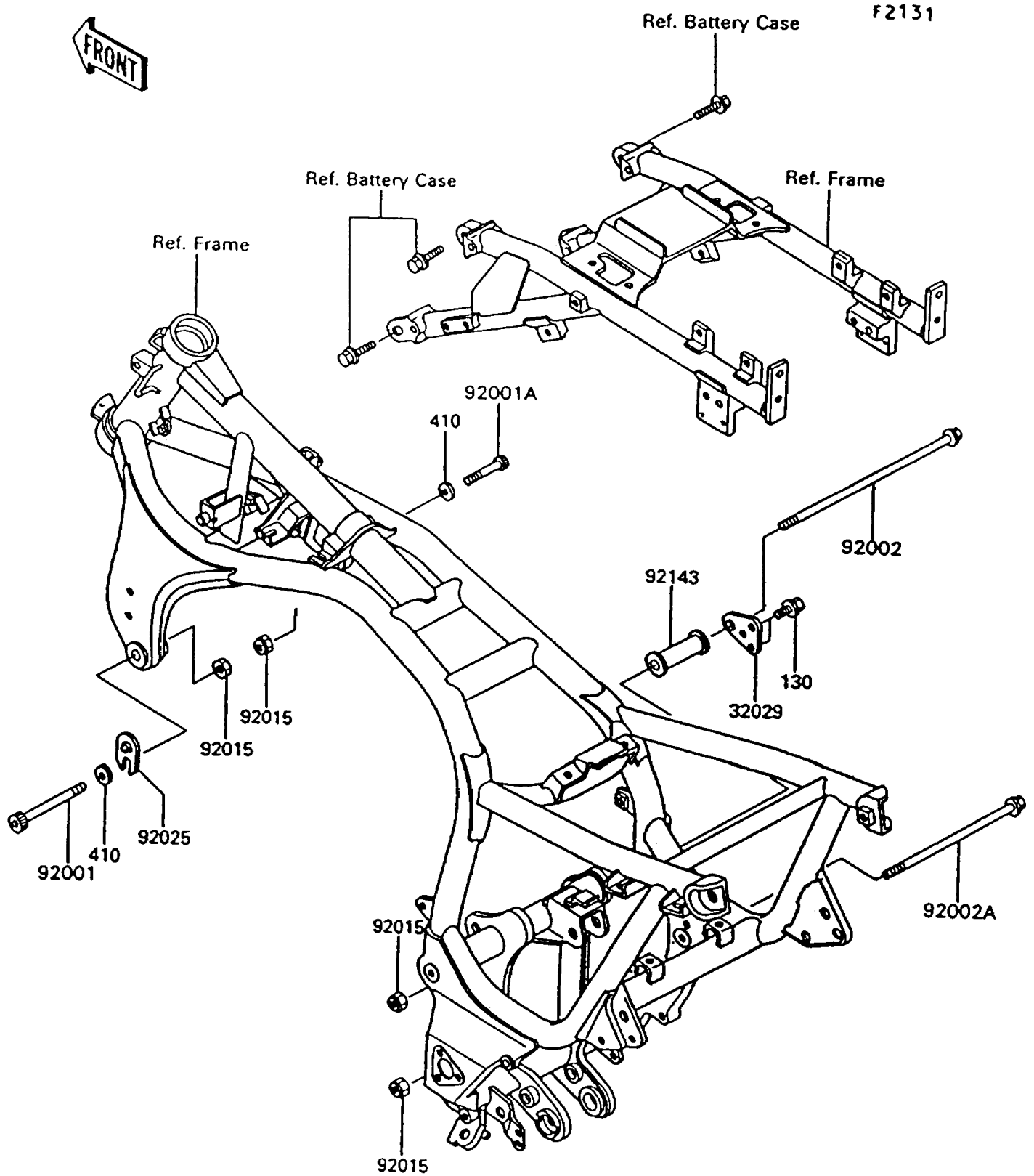

1994 Concours PARTS LIST

Frame Fittings

ITEM NAME	PART NUMBER	QUANTITY
BRACKET-ENGINE,RR,UPP,RH (Ref # 32029)	32029-1473	1
BOLT,SOCKET,10X100 (Ref # 92001)	92001-1888	1
BOLT,SOCKET,10X72 (Ref # 92001A)	92001-1889	1
BOLT,FLANGED,10X265 (Ref # 92002)	92002-1722	1
BOLT,FLANGED,10X215 (Ref # 92002A)	92002-1822	1
NUT,FLANGED,10MM (Ref # 92015)	92015-1502	4
SHIM,ENGINE MOUNT,T=1.2 (Ref # 92025)	92025-1616	AR
COLLAR,L=57.5 (Ref # 92143)	92143-1027	1
BOLT-FLANGED (Ref # 130)	130J0812	2
WASHER-PLAIN-SMALL,10MM (Ref # 410)	410B1000	2