

1994 Concours PARTS DIAGRAM

Rear Suspension

F2150

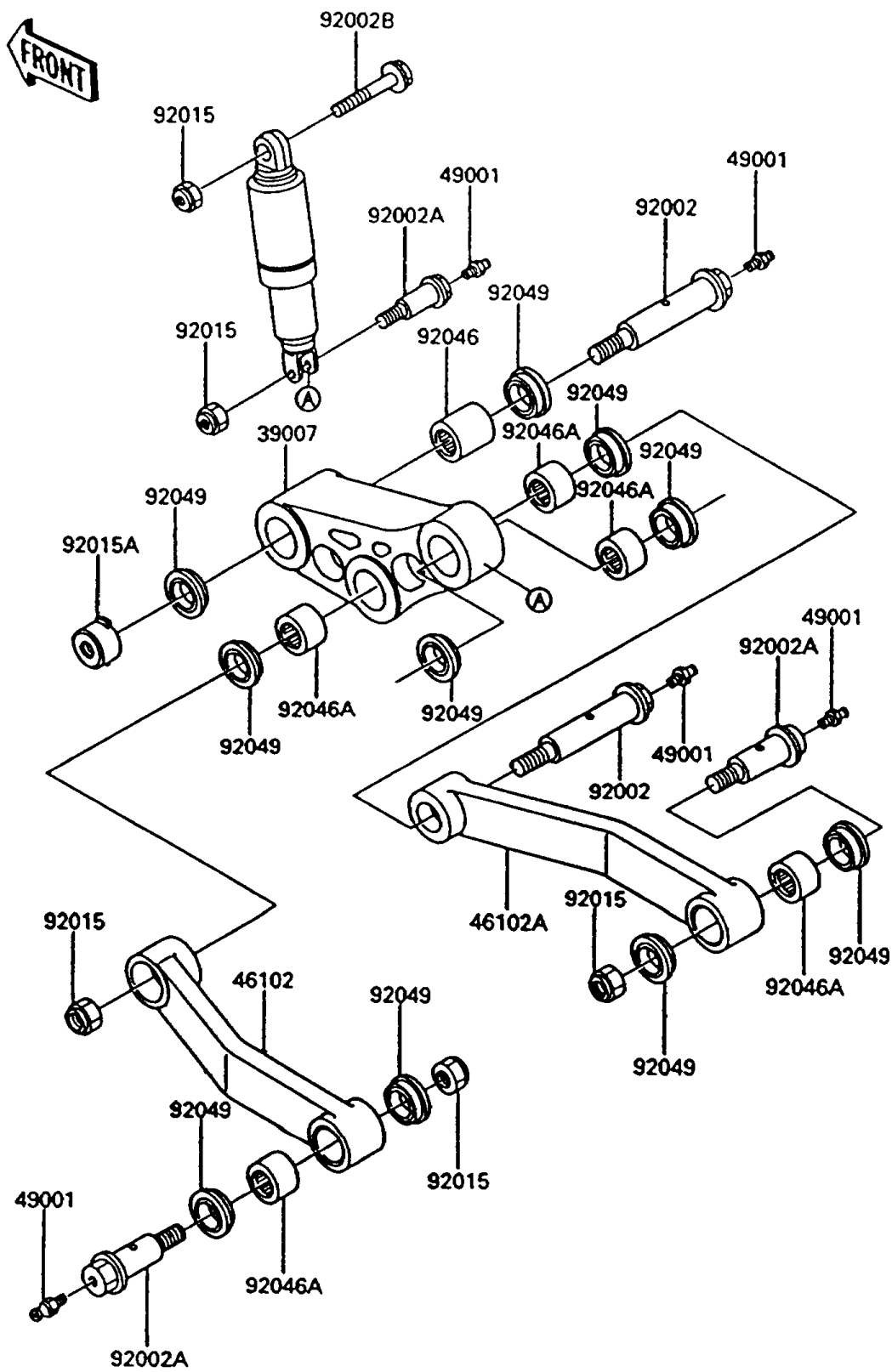

1994 Concours PARTS LIST

Rear Suspension

ITEM NAME	PART NUMBER	QUANTITY
ARM-SUSP,UNI TRAK (Ref # 39007)	39007-1094	1
ROD,SUSPENSION,LH (Ref # 46102)	46102-1175	1
ROD,SUSPENSION,RH (Ref # 46102A)	46102-1176	1
NIPPLE-GREASE (Ref # 49001)	49001-1051	5
BOLT,SUSPENSION ARM (Ref # 92002)	92002-1709	2
BOLT,SUSPENSION ARM (Ref # 92002A)	92002-1710	3
BOLT,FLANGED,12X50 (Ref # 92002B)	92002-1727	1
NUT,LOCK,12MM,BLACK (Ref # 92015)	92015-1190	5
NUT,12MM (Ref # 92015A)	92015-1482	1
BEARING-NEEDLE,BM202726 (Ref # 92046)	92046-1110	1
BEARING-NEEDLE,BM202715 (Ref # 92046A)	92046-1112	5
SEAL-OIL,ARM,CNT (Ref # 92049)	92049-1109	10