

1993 Concours PARTS DIAGRAM

Clutch Master Cylinder

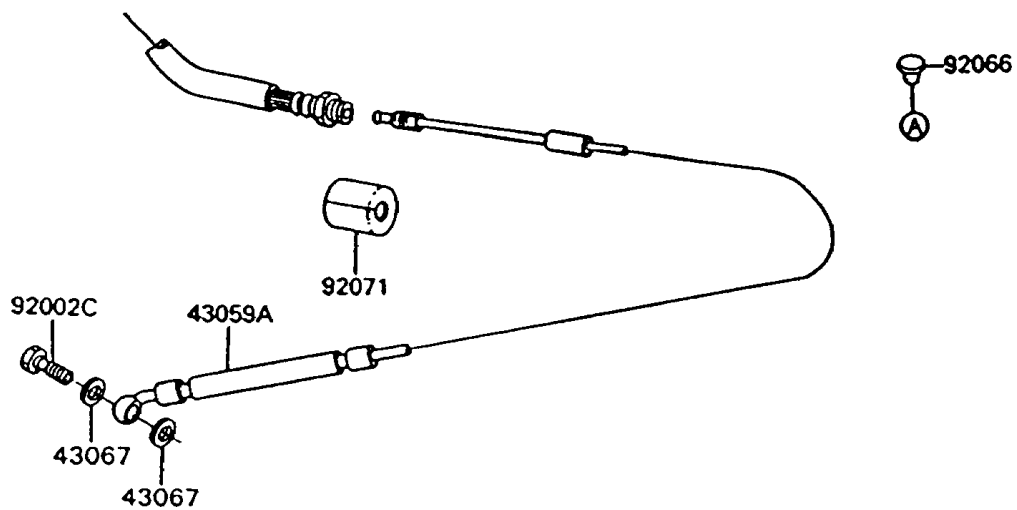
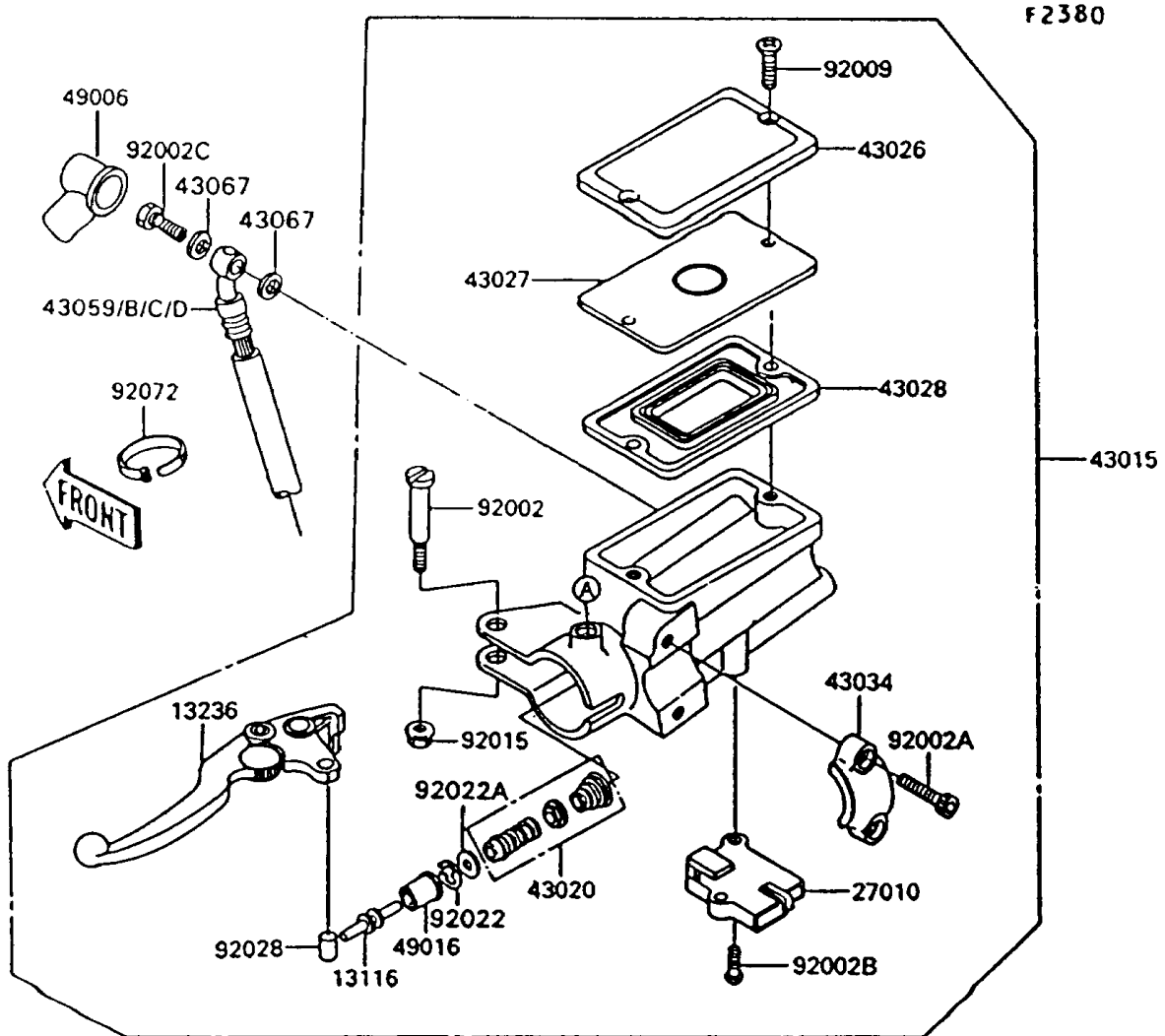

1993 Concours PARTS LIST

Clutch Master Cylinder

ITEM NAME	PART NUMBER	QUANTITY
ROD-PUSH,MASTER CYLINDER (Ref # 13116)	13116-1110	1
LEVER-COMP,CLUTCH (Ref # 13236)	13236-1186	1
SWITCH,CLUTCH (Ref # 27010)	27010-1171	1
CYLINDER-ASSY-MASTER,CLUTCH (Ref # 43015)	43015-1499	1
PISTON-COMP-BRAKE,CLUTCH (Ref # 43020)	43020-1055	1
CAP-BRAKE (Ref # 43026)	43026-1076	1
PLATE-DIAPHRAGM (Ref # 43027)	43027-1055	1
DIAPHRAGM,MASTER CYLINDER (Ref # 43028)	43028-1058	1
HOLDER-BRAKE,MASTER CYLINDER (Ref # 43034)	43034-1054	1
HOSE-CLUTCH,FOR LOW HANDLE (Ref # 43059)	43059-1339	1
HOSE-BRAKE,CLUTCH (Ref # 43059A)	43059-1340	1
HOSE-CLUTCH,FOR UP HANDLE (Ref # 43059B)	43059-1402	1
WASHER,10.5X15X1.5 (Ref # 43067)	43067-001	4
BOOT,DUST (Ref # 49006)	49006-1040	1
COVER-SEAL,MASTER CYLINDER (Ref # 49016)	49016-1044	1
BOLT,LEVER SET (Ref # 92002)	92002-1322	1
BOLT,SOCKET,6X20 (Ref # 92002A)	92002-1324	2
SCREW (Ref # 92002B)	92002-1325	1
BOLT,OIL,L=23 (Ref # 92002C)	92002-1888	2
SCREW,4MM (Ref # 92009)	92009-1458	2
NUT,FLANGED,6MM (Ref # 92015)	92015-1233	1
WASHER,PISTON (Ref # 92022)	92022-1605	1
WASHER,PISTON (Ref # 92022A)	92022-1606	1
BUSHING,MASTER CYLINDER (Ref # 92028)	92028-1310	1
PLUG,9.5X8,POLYETHYLENE (Ref # 92066)	92066-1077	1
GROMMET (Ref # 92071)	92071-1143	1
BAND,L=185 (Ref # 92072)	92072-1195	1