

2013 KLX® 250S PARTS DIAGRAM

Rear Master Cylinder

F2293

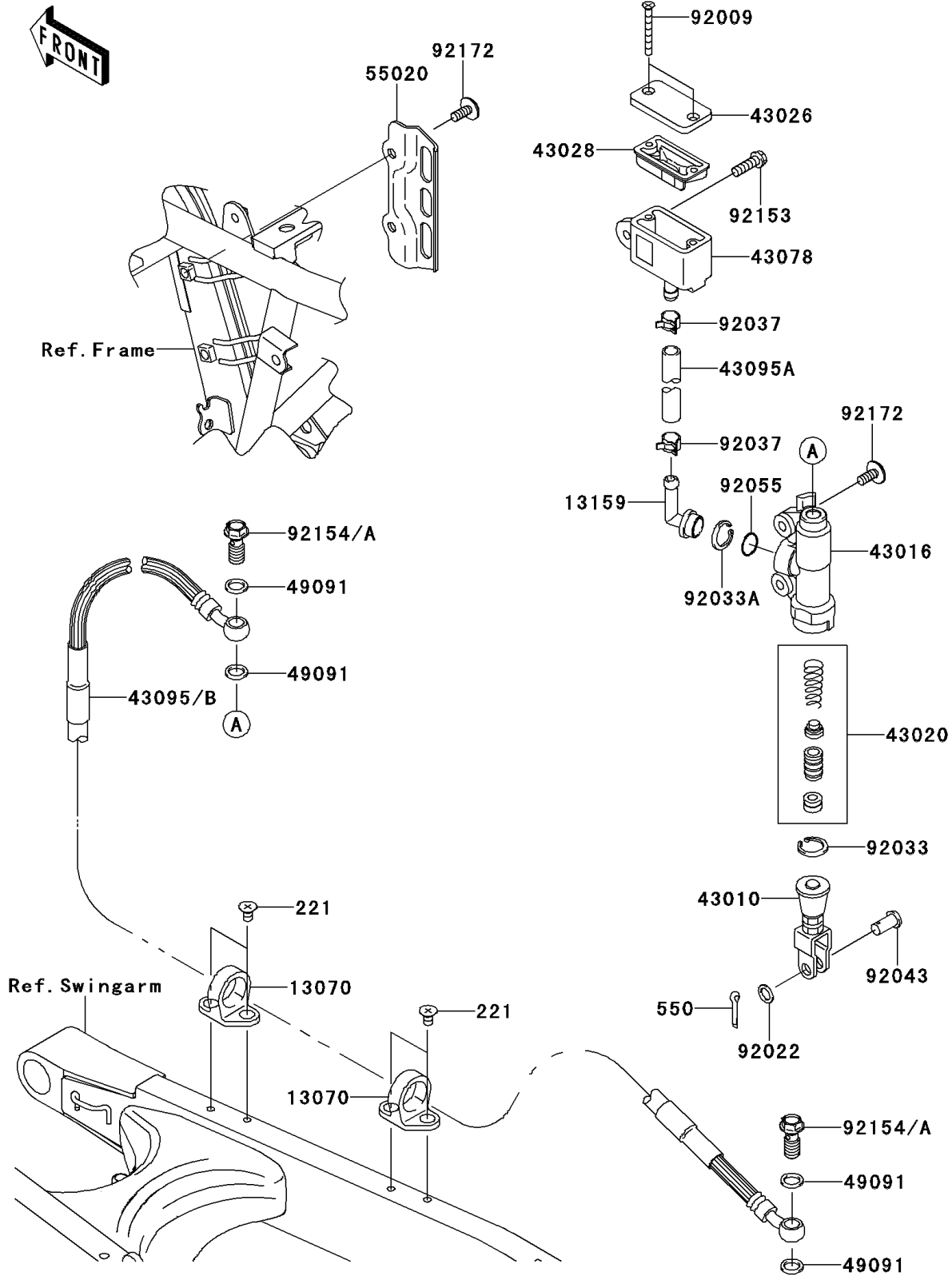

2013 KLX® 250S PARTS LIST

Rear Master Cylinder

ITEM NAME	PART NUMBER	QUANTITY
SCREW-CSK-CROS,6X10 (Ref # 221)	221AA0610	4
PIN-COTTER,2.0X15 (Ref # 550)	550AA2015	1
GUIDE,HOSE (Ref # 13070)	13070-1144	2
CONNECTOR (Ref # 13159)	13159-1056	1
ROD-ASSY-BRAKE (Ref # 43010)	43010-1068	1
CYLINDER-MASTER (Ref # 43016)	43016-1149	1
PISTON-COMP-BRAKE (Ref # 43020)	43020-1094	1
CAP-BRAKE (Ref # 43026)	43026-1075	1
DIAPHRAGM (Ref # 43028)	43028-1067	1
RESERVOIR (Ref # 43078)	43078-1189	1
HOSE-BRAKE,RR MASTER CYLINDER (Ref # 43095A)	43095-0451	1
HOSE-BRAKE,RR (Ref # 43095B)	43095-0691	1
WASHER-SEAL,10.1X14.5X1.5 (Ref # 49091)	49091-0001	4
GUARD,RR BRAKE RESERVOIR HOSE (Ref # 55020)	55020-1489	1
SCREW,4X40 (Ref # 92009)	92009-1596	2
WASHER,8.5X13X1 (Ref # 92022)	92022-1028	1
RING-SNAP,20.9X24.6X1.2 (Ref # 92033)	92033-0079	1
RING-SNAP,20.5MM (Ref # 92033A)	92033-1186	1
CLAMP (Ref # 92037)	92037-1710	2
PIN (Ref # 92043)	92043-0004	1
RING-O,MASTER CYLINDER (Ref # 92055)	92055-1251	1
BOLT,6X20 (Ref # 92153)	92153-0502	1
BOLT,FLANGED,10X23 (Ref # 92154A)	92154-0732	2
SCREW,6X14 (Ref # 92172)	92172-0401	4