

1994 Concours PARTS DIAGRAM

Accessory

F2910

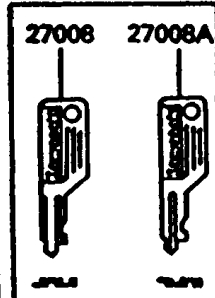
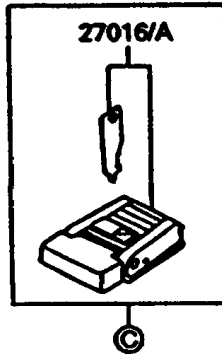
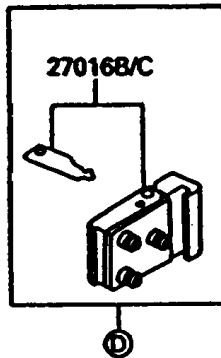
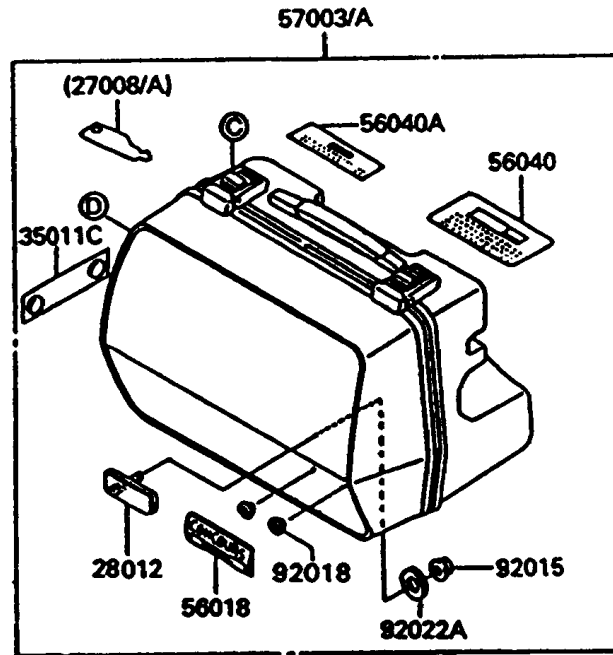
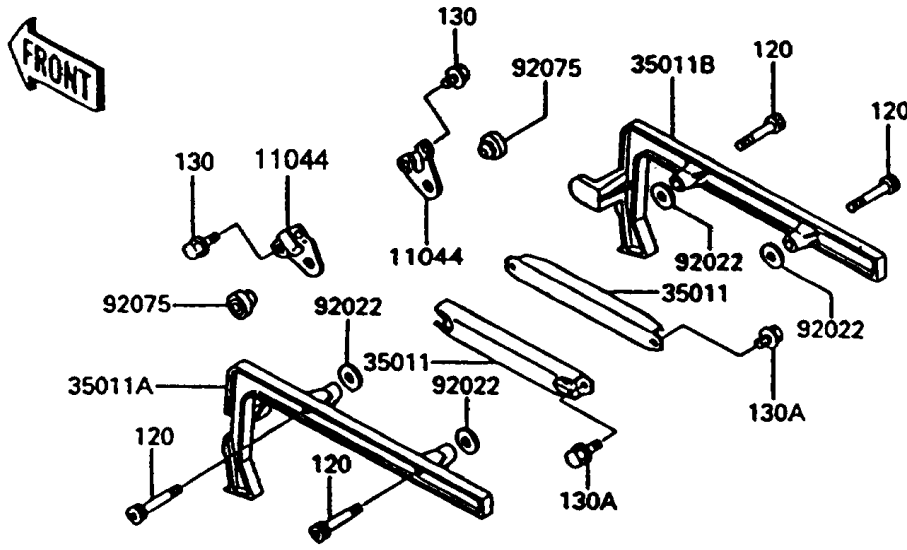

1994 Concours PARTS LIST

Accessory

ITEM NAME	PART NUMBER	QUANTITY
BRACKET,SIDE BAG STOPPER (Ref # 11044)	11044-1918	2
KEY-LOCK,#A,SIDE BAG (Ref # 27008)	27008-1127-AA	AR
KEY-LOCK,#B,SIDE BAG (Ref # 27008A)	27008-1127-BB	AR
LOCK-ASSY,#A,SIDE BAG (Ref # 27016)	27016-1066-AA	4
LOCK-ASSY,#B,SIDE BAG (Ref # 27016A)	27016-1066-BB	4
LOCK-ASSY,#A,SIDE BAG MOUNT (Ref # 27016B)	27016-1067-AA	2
LOCK-ASSY,#B,SIDE BAG MOUNT (Ref # 27016C)	27016-1067-BB	2
REFLECTOR-REFLEX (Ref # 28012)	28012-1077	2
STAY,BAG (Ref # 35011)	35011-1299	2
STAY,BAG,LH (Ref # 35011A)	35011-1300	1
STAY,BAG,RH (Ref # 35011B)	35011-1301	1
STAY,SIDE BAG (Ref # 35011C)	35011-1302	2
MARK,SIDE BAG,CONCOURS (Ref # 56018)	56018-1948	2
LABEL-WARNING,SIDE BAG,PAYLOAD (Ref # 56040)	56040-1178	2
LABEL-WARNING,SIDE BAG,LOCK (Ref # 56040A)	56040-1192	2
BAG-ASSY,SIDE,LH (Ref # 57003)	57003-1068	1
BAG-ASSY,SIDE,RH (Ref # 57003A)	57003-1069	1
NUT,LOCK 5MM (Ref # 92015)	92015-1263	2
NUT,PUSH,3MM (Ref # 92018)	92018-005	4
WASHER,8.5X20X1.6,BLACK (Ref # 92022)	92022-1317	4
WASHER,NYLON,5.3X11.5X1.5 (Ref # 92022A)	92022-1521	2
DAMPER (Ref # 92075)	92075-1859	2
BOLT-SOCKET (Ref # 120)	120S0860	4
BOLT-FLANGED,6X12 (Ref # 130)	130G0612	4
BOLT-FLANGED,8X16,BLACK (Ref # 130A)	130J0816	4