

2010 KLX® 250S PARTS DIAGRAM

Handlebar

F2310

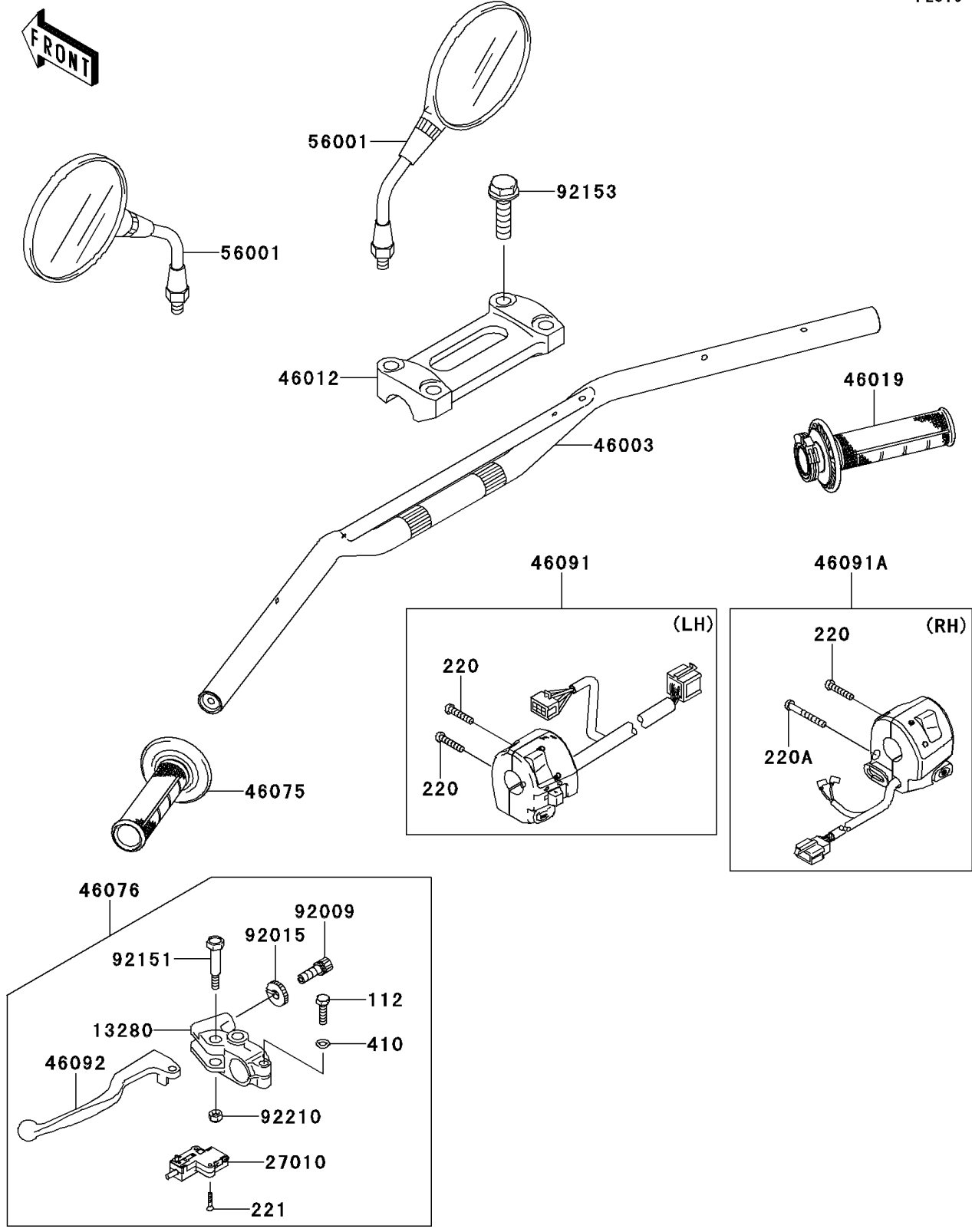

2010 KLX®250S PARTS LIST

Handlebar

ITEM NAME	PART NUMBER	QUANTITY
BOLT-UPSET,6X22 (Ref # 112)	112BB0622	1
SCREW-PAN-CROS,5X25 (Ref # 220)	220AB0525	3
SCREW-PAN-CROS,5X40 (Ref # 220A)	220AB0540	1
SCREW-CSK-CROS,3X16 (Ref # 221)	221AB0316	2
WASHER-PLAIN-SMALL,6MM (Ref # 410)	410AB0600	1
HOLDER,CLUTCH LEVER (Ref # 13280)	13280-0105	1
SWITCH,CLUTCH,BLACK (Ref # 27010)	27010-1094	1
HANDLE,P.SILVER (Ref # 46003)	46003-0164-458	1
HOLDER-HANDLE,UPP,F.S.BLACK (Ref # 46012)	46012-0010-18R	1
GRIP-ASSY,THROTTLE (Ref # 46019)	46019-0036	1
GRIP,LH (Ref # 46075)	46075-0082	1
LEVER-ASSY-GRIP,CLUTCH (Ref # 46076)	46076-1244	1
HOUSING-ASSY-CONTROL,LH (Ref # 46091)	46091-0163	1
HOUSING-ASSY-CONTROL,RH (Ref # 46091A)	46091-0180	1
LEVER-GRIP,CLUTCH (Ref # 46092)	46092-1206	1
MIRROR-ASSY (Ref # 56001)	56001-1285	2
SCREW,CABLE ADJUST,8MM,BLACK (Ref # 92009)	92009-1134	1
NUT,CABLE ADJUST LOCK,8MM,BLK (Ref # 92015)	92015-1197	1
BOLT,LEVER SET (Ref # 92151)	92151-1986	1
BOLT,FLANGED,8X30 (Ref # 92153)	92153-1519	4
NUT,LOCK,6MM (Ref # 92210)	92210-0006	1