

1988 Voyager XII PARTS DIAGRAM

Transmission

E1361-0173

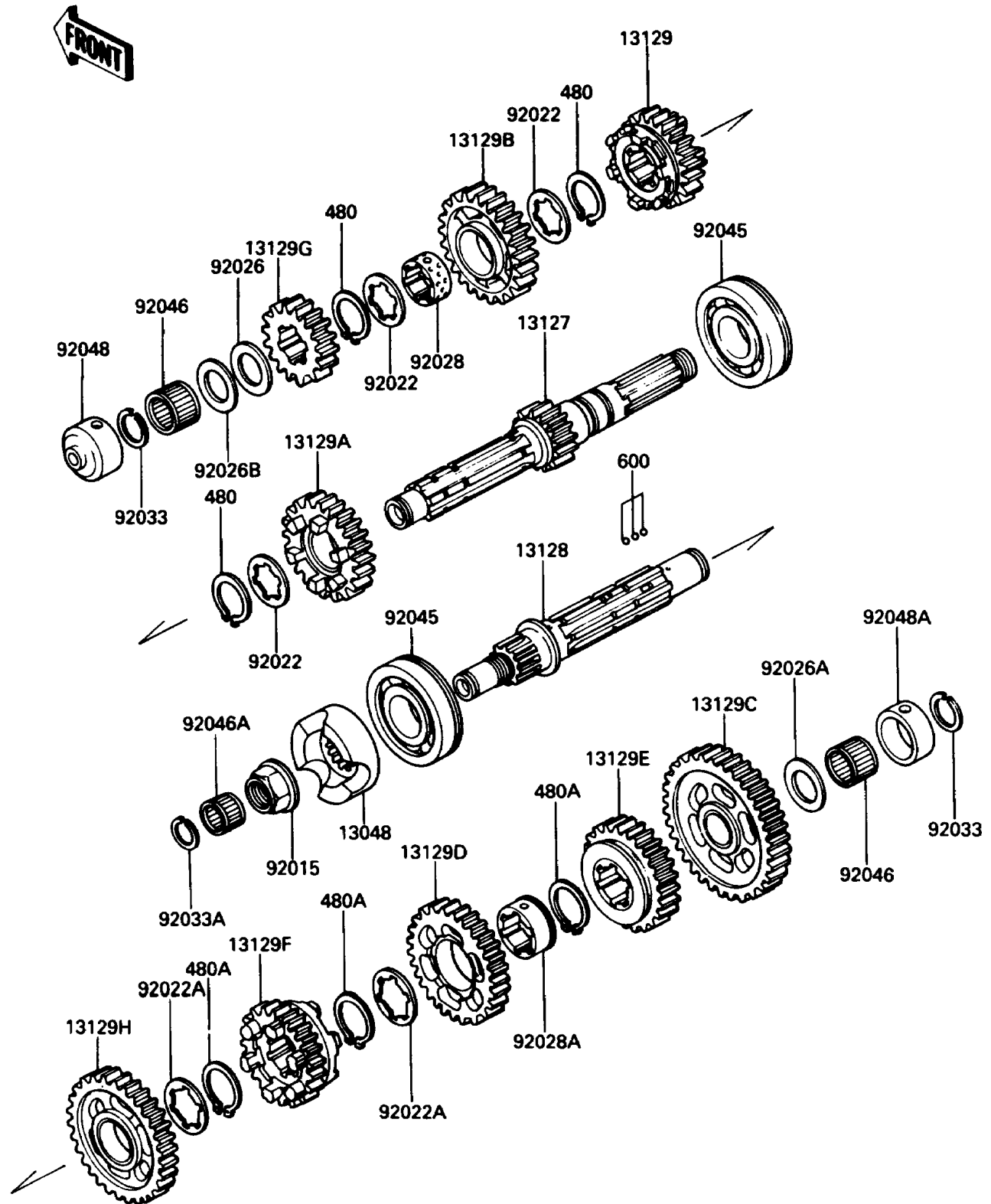

1988 Voyager XII PARTS LIST

Transmission

ITEM NAME	PART NUMBER	QUANTITY
CIRCLIP-TYPE-C,28MM (Ref # 480)	480J2800	3
CIRCLIP (Ref # 480A)	480J2900	3
BALL-STEEL,5/32" (Ref # 600)	600A0500	3
CAM-DAMPER (Ref # 13048)	13048-1066	1
SHAFT-TRANSMISSION INPUT,15T (Ref # 13127)	13127-1133	1
SHAFT-TRANSMISSION OUTPUT (Ref # 13128)	13128-1130	1
GEAR,INPUT 3RD,24T (Ref # 13129)	13129-1765	1
GEAR,INPUT 4TH,28T (Ref # 13129A)	13129-1766	1
GEAR,INPUT TOP,31T (Ref # 13129B)	13129-1767	1
GEAR,OUTPUT LOW,41T (Ref # 13129C)	13129-1768	1
GEAR,OUTPUT 3RD,32T (Ref # 13129D)	13129-1770	1
GEAR,OUTPUT 4TH,29T (Ref # 13129E)	13129-1771	1
GEAR,OUTPUT TOP,26T (Ref # 13129F)	13129-1772	1
GEAR,INPUT 2ND,20T (Ref # 13129G)	13129-1836	1
GEAR,OUTPUT 2ND,36T (Ref # 13129H)	13129-1837	1
NUT (Ref # 92015)	92015-1543	1
WASHER,TOOTHED,28.3X35.5X1.5 (Ref # 92022)	92024-042	3
WASHER,TOOTHED,30.3X40X1.5 (Ref # 92022A)	92024-043	2
SPACER,22X35.5X1.0 (Ref # 92026)	92026-1020	1
SPACER,22X35.5X2.4 (Ref # 92026A)	92026-1225	1
SPACER,22X35.5X1.8 (Ref # 92026B)	92026-1226	1
BUSHING,TOP GEAR (Ref # 92028)	92028-1124	1
BUSHING (Ref # 92028A)	92028-1403	1
RING-SNAP,20X25.5X1.2 (Ref # 92033)	92033-025	2
RING-SNAP (Ref # 92033A)	92033-1208	1
BEARING-BALL (Ref # 92045)	92045-1197	2
BEARING-NEEDLE,FWF-223014 (Ref # 92046)	92046-031	2
BEARING-NEEDLE,K182420V1 (Ref # 92046A)	92046-1154	1
RACE,INPUT SHAFT (Ref # 92048)	92048-1052	1

1988 Voyager XII PARTS LIST

Transmission

ITEM NAME	PART NUMBER	QUANTITY
RACE,30X38X15 (Ref # 92048A)	92048-1053	1