

1989 Voyager XII PARTS DIAGRAM

Frame

F2120

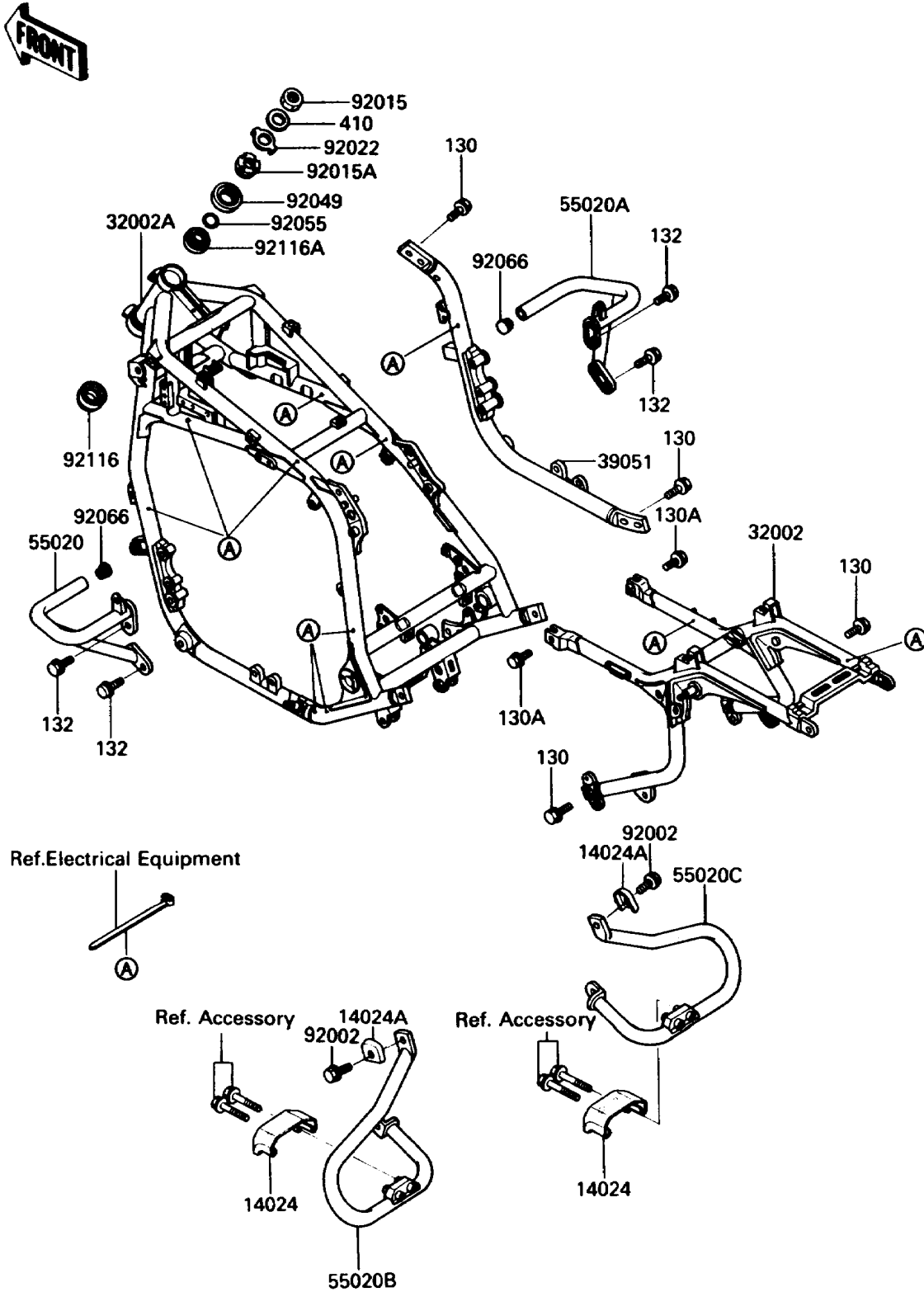

1989 Voyager XII PARTS LIST

Frame

ITEM NAME	PART NUMBER	QUANTITY
BOLT-FLANGED (Ref # 130)	130S1016	6
BOLT-FLANGED,10X40 (Ref # 130A)	130S1040	2
BOLT-FLANGED-SMALL,8X12 (Ref # 132)	132J0812	4
W-PLAIN-S (Ref # 410)	410F1800	1
COVER,SIDE BAG STAY (Ref # 14024)	14024-1335	2
COVER,SIDE BAG STAY (Ref # 14024A)	14024-1336	2
FRAME-COMP,RR (Ref # 32002)	32002-1861	1
FRAME-COMP,FR (Ref # 32002A)	32002-1947	1
FRAME-COMP-SIDE (Ref # 39051)	39051-1052	1
GUARD,FR,LH (Ref # 55020)	55020-1212	1
GUARD,FR,RH (Ref # 55020A)	55020-1213	1
GUARD,RR,LH (Ref # 55020B)	55020-1214	1
GUARD,RR,RH (Ref # 55020C)	55020-1215	1
BOLT,FLANGED,10X20 (Ref # 92002)	92002-1827	2
NUT,18MM (Ref # 92015)	92015-1404	1
NUT,25MM,T=12 (Ref # 92015A)	92015-1546	1
WASHER,CLAW,18.5X30X2.3 (Ref # 92022)	92022-1555	1
SEAL-OIL,STEERING STEM (Ref # 92049)	92049-1214	1
RING-O,ID=24.5 (Ref # 92055)	92055-1459	1
PLUG,22X3 (Ref # 92066)	32112-008	2
BEARING-ROLLER,LWR,32006JR RS (Ref # 92116)	92116-1008	1
BEARING-ROLLER,HI-CAP32005JR-1 (Ref # 92116A)	92116-1056	1