

# 1989 Voyager XII PARTS DIAGRAM

Swing Arm

F2141-0044

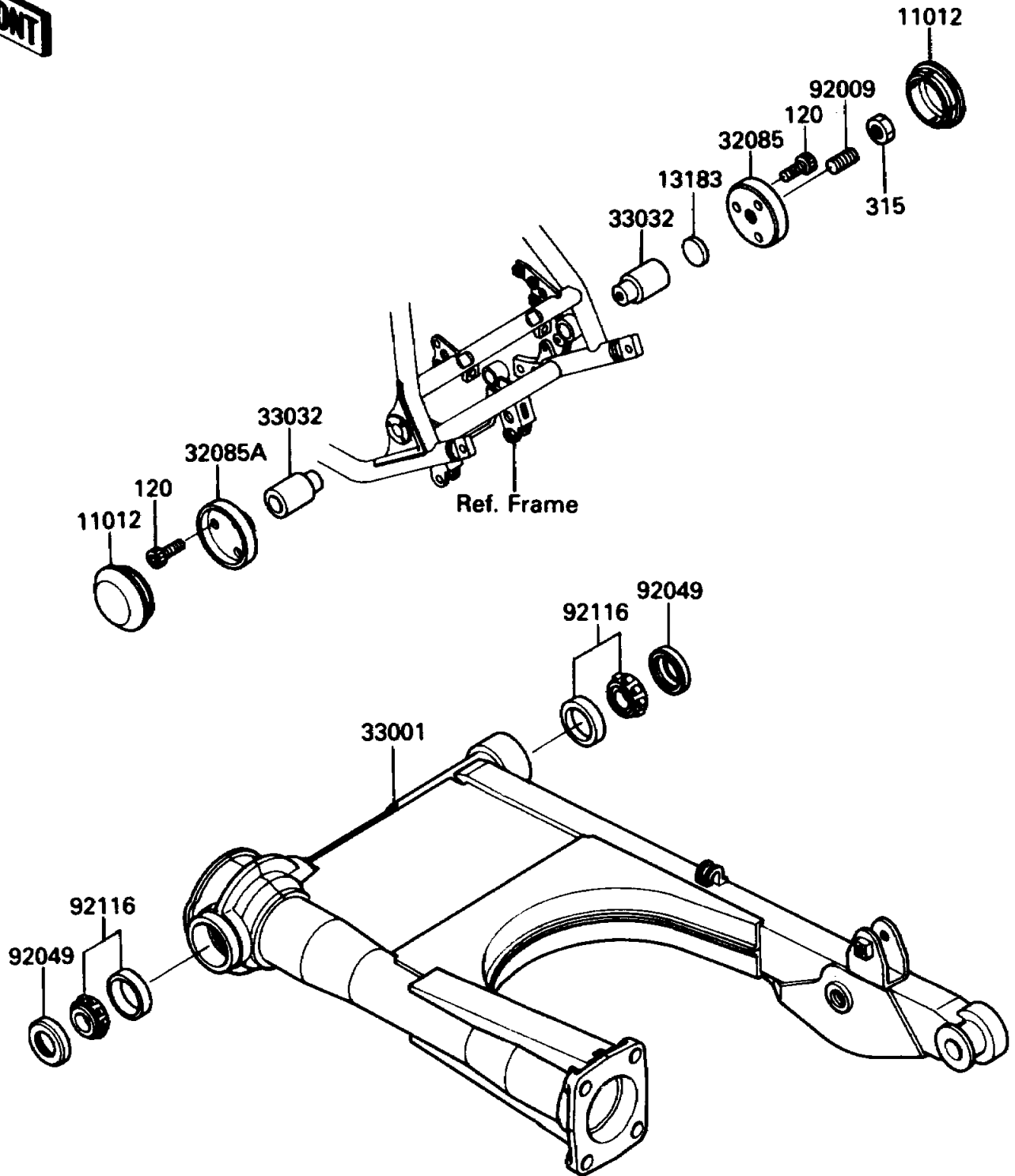

# 1989 Voyager XII PARTS LIST

## Swing Arm

ITEM NAME	PART NUMBER	QUANTITY
BOLT-SOCKET (Ref # 120)	120S0612	6
NUT-HEX-FINE (Ref # 315)	315C1200	1
CAP,SWING ARM (Ref # 11012)	11012-1433	2
PLATE,25X4.5 (Ref # 13183)	13183-1004	1
STOPPER,SWING ARM SHAFT,RH (Ref # 32085)	32085-1227	1
STOPPER,SWING ARM SHAFT,LH (Ref # 32085A)	32085-1228	1
ARM-COMP-SWING (Ref # 33001)	33001-1304	1
SHAFT-SWING ARM (Ref # 33032)	33032-1120	2
SCREW,SOCKET,12X22 (Ref # 92009)	92009-1374	1
SEAL-OIL,26406 (Ref # 92049)	92049-1030	2
BEARING-ROLLER,4T30203E1 (Ref # 92116)	92116-1001	2