

1989 Voyager XII PARTS DIAGRAM

Footrest

F2160-0152

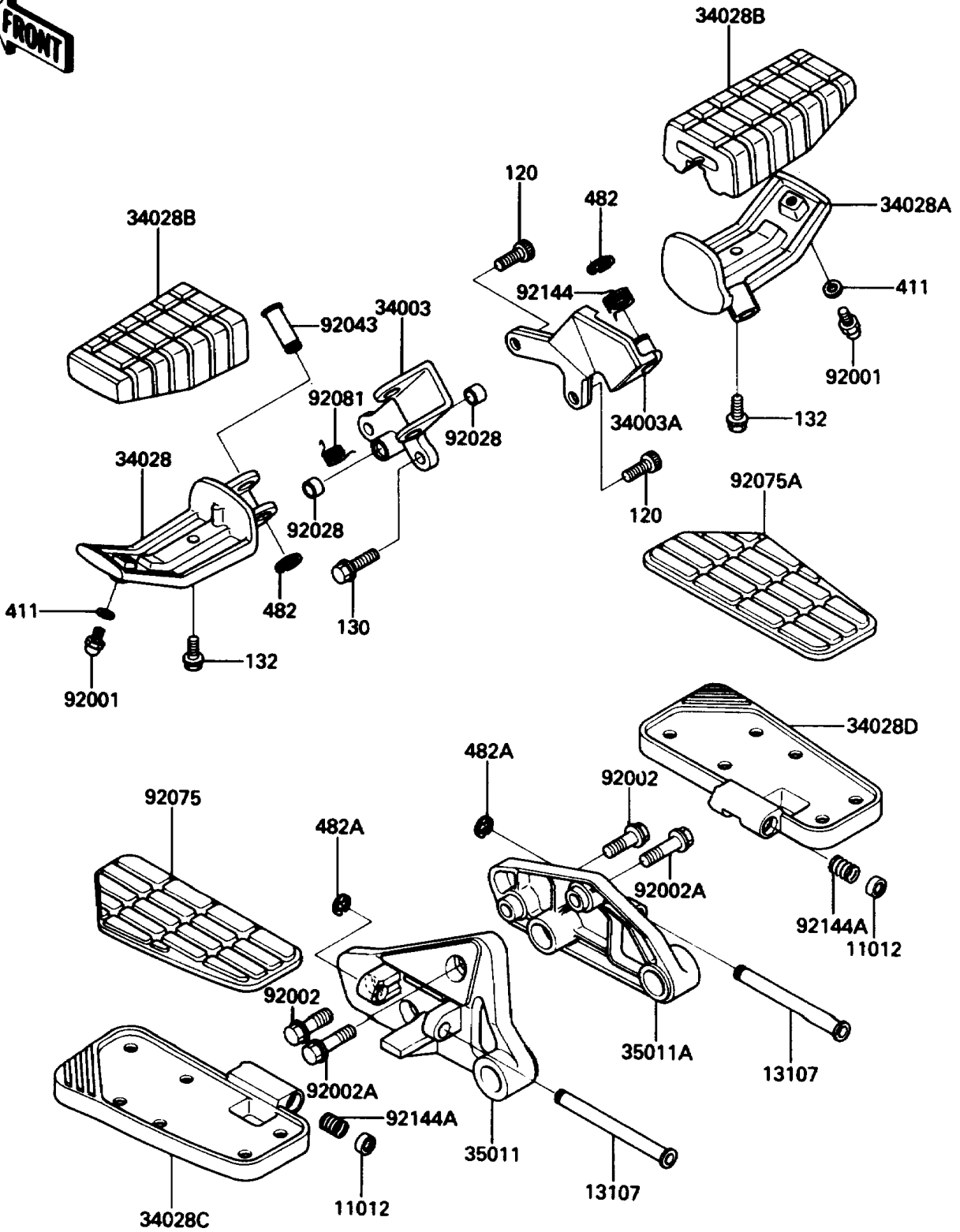

1989 Voyager XII PARTS LIST

Footrest

ITEM NAME	PART NUMBER	QUANTITY
BOLT-SOCKET (Ref # 120)	120S0814	2
BOLT-FLANGED,8X20 (Ref # 130)	130J0820	2
BOLT-FLANGED-SMALL (Ref # 132)	132G0616	2
WASHER-PLAIN,6MM (Ref # 411)	411B0600	2
CIRCLIP-TYPE-E,10MM (Ref # 482)	482L0100	2
CIRCLIP-TYPE-E (Ref # 482A)	482L0200	2
CAP,MUFFLER STAY (Ref # 11012)	11012-1498	2
SHAFT,REAR STEP (Ref # 13107)	13107-1174	2
HOLDER-STEP,FR,LH (Ref # 34003)	34003-1253	1
HOLDER-STEP,FR,RH (Ref # 34003A)	34003-1254	1
STEP,FR,LH (Ref # 34028)	34028-1183	1
STEP,FR,RH (Ref # 34028A)	34028-1184	1
STEP,FR,RUBBER (Ref # 34028B)	34028-1205	2
STEP,RR,LH (Ref # 34028C)	34028-1231	1
STEP,RR,RH (Ref # 34028D)	34028-1232	1
STAY,MUFFLER,LH (Ref # 35011)	35011-1278	1
STAY,MUFFLER,RH (Ref # 35011A)	35011-1279	1
BOLT,6X10 (Ref # 92001)	92001-1905	2
BOLT,FLANGED,10X25 (Ref # 92002)	92002-1828	2
BOLT,FLANGED,10X35 (Ref # 92002A)	92002-1829	2
BUSHING,13X15X20 (Ref # 92028)	92028-1251	2
PIN,12X37 (Ref # 92043)	92043-1144	1
DAMPER,REAR STEP,LH,RUBBER (Ref # 92075)	92075-1803	1
DAMPER,REAR STEP,RH,RUBBER (Ref # 92075A)	92075-1804	1
SPRING,STEP RETURN (Ref # 92081)	92081-1587	1
SPRING,STEP RETURN (Ref # 92144)	92081-1956	1
SPRING,REAR STEP (Ref # 92144A)	92081-1957	2