

1989 Voyager XII PARTS DIAGRAM

Turn Signal

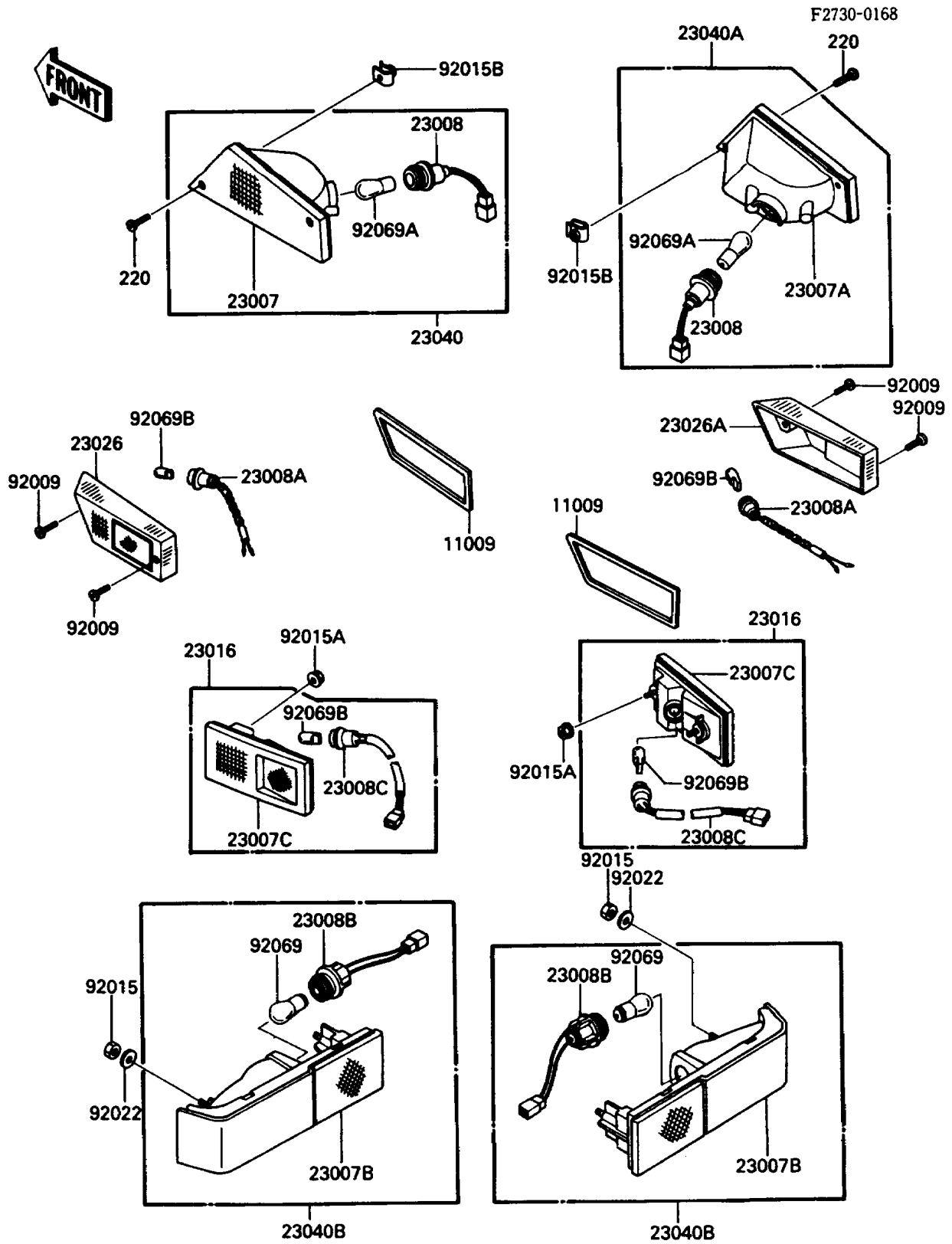

1989 Voyager XII PARTS LIST

Turn Signal

ITEM NAME	PART NUMBER	QUANTITY
SCREW-PAN-CROS,4X20 (Ref # 220)	220D0420	4
GASKET,SIDE MARKER,FR (Ref # 11009)	11009-1615	2
LENS-COMP,SIGNAL LAMP,FR,LH (Ref # 23007)	23007-1146	1
LENS-COMP,SIGNAL LAMP,FR,RH (Ref # 23007A)	23007-1147	1
LENS-COMP,SIGNAL LAMP,RR (Ref # 23007B)	23007-1148	2
LENS-COMP,SIDE MARKER,RR (Ref # 23007C)	23007-1149	2
SOCKET-ASSY,SIGNAL LAMP,FR (Ref # 23008)	23008-1184	2
SOCKET-ASSY,SIDE MARKER,FR (Ref # 23008A)	23008-1292	2
SOCKET-ASSY,SIGNAL LAMP,RR (Ref # 23008B)	23008-1301	2
SOCKET-ASSY,SIDE MARKER,RR (Ref # 23008C)	23008-1302	2
LAMP-ASSY,SIDE MARKER,RR (Ref # 23016)	23016-1068	2
LENS,SIDE MARKER,FR,LH (Ref # 23026)	23026-1071	1
LENS,SIDE MARKER,FR,RH (Ref # 23026A)	23026-1072	1
LAMP-SIGNAL,FR,LH (Ref # 23040)	23040-1128	1
LAMP-SIGNAL,FR,RH (Ref # 23040A)	23040-1129	1
LAMP-SIGNAL,RR (Ref # 23040B)	23040-1130	2
SCREW,4X18 (Ref # 92009)	92009-1355	4
NUT,FLANGED,6MM (Ref # 92015)	92015-1233	4
NUT,FLANGED,5MM (Ref # 92015A)	92015-1328	4
NUT,4MM (Ref # 92015B)	92015-1567	4
WASHER,6.5X20X1.6,BLACK (Ref # 92022)	92022-1346	4
BULB,12V 32CP(23W) (Ref # 92069)	92069-055	2
BULB,12V 32/3CP(23/8W) (Ref # 92069A)	92069-060	2
BULB,12V 3CP (Ref # 92069B)	92069-1066	4