

1989 Voyager XII PARTS DIAGRAM

Audio

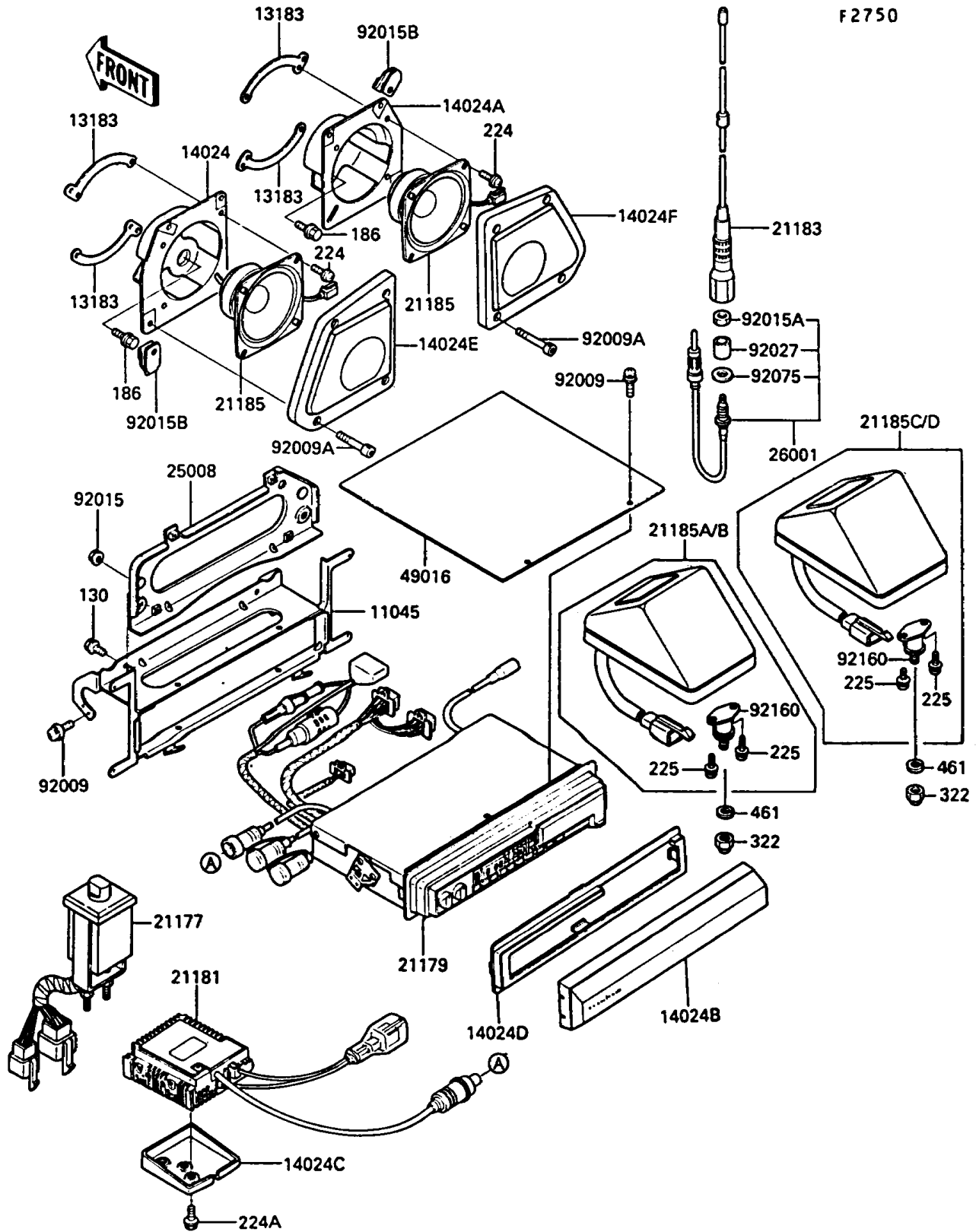

1989 Voyager XII PARTS LIST

Audio

ITEM NAME	PART NUMBER	QUANTITY
BOLT-FLANGED,5X12 (Ref # 130)	130B0512	2
BOLT-UPSET-WP (Ref # 186)	186D0612	4
SCREW-PAN-WP-CROS (Ref # 224)	224C0516	8
SCREW-PAN-WP-CROS (Ref # 224A)	224D0512	3
SCREW-PAN-WSP-CROS,4X12 (Ref # 225)	225D0412	12
NUT-CAP,6MM (Ref # 322)	322N0600	6
WASHER-SPRING,6MM (Ref # 461)	461F0600	6
BRACKET,AUDIO (Ref # 11045)	11044-1721	1
PLATE,SPEAKER (Ref # 13183)	13169-1655	4
COVER,SPEAKER,LH (Ref # 14024)	14024-1201	1
COVER,SPEAKER,RH (Ref # 14024A)	14024-1202	1
COVER,TUNER (Ref # 14024B)	14024-1203	1
COVER,AMPLIFIER (Ref # 14024C)	14024-1304	1
COVER (Ref # 14024D)	14024-1326	1
COVER,SPEAKER,LH (Ref # 14024E)	14024-1508	1
COVER,SPEAKER,RH (Ref # 14024F)	14024-1509	1
CONTROLLER (Ref # 21177)	21177-1051	1
RADIO-TUNER (Ref # 21179)	21179-1052	1
AMPLIFIER (Ref # 21181)	21181-1054	1
ANTENNA,ROD (Ref # 21183)	21183-1054	1
SPEAKER,FR (Ref # 21185)	21185-1056	2
SPEAKER,RR,LH,P.B.BEIGE (Ref # 21185B)	21185-1057-X8	1
SPEAKER,RR,RH,P.B.BEIGE (Ref # 21185D)	21185-1058-X8	1
BRACKET-METER (Ref # 25008)	25008-1125	1
HARNESS,ANTENNA (Ref # 26001)	26001-1794	1
COVER-SEAL,AUDIO (Ref # 49016)	49016-1122	1
SCREW,PAN-CROS,W/WASHER (Ref # 92009)	92009-1259	8
SCREW,SOCKET,4X20 (Ref # 92009A)	92009-1450	8
NUT,FLANGED,6MM (Ref # 92015)	92015-1193	2

1989 Voyager XII PARTS LIST

Audio

ITEM NAME	PART NUMBER	QUANTITY
NUT,ANTENNA (Ref # 92015A)	92015-1313	1
NUT,4MM (Ref # 92015B)	92015-1593	6
COLLAR,ANTENNA (Ref # 92027)	92027-1681	1
DAMPER,WASHER,15X26X2 (Ref # 92075)	92075-1869	1
DAMPER,REAR SPEAKER (Ref # 92160)	92160-1158	6