

1988 Voyager XII PARTS DIAGRAM

Ignition Switch

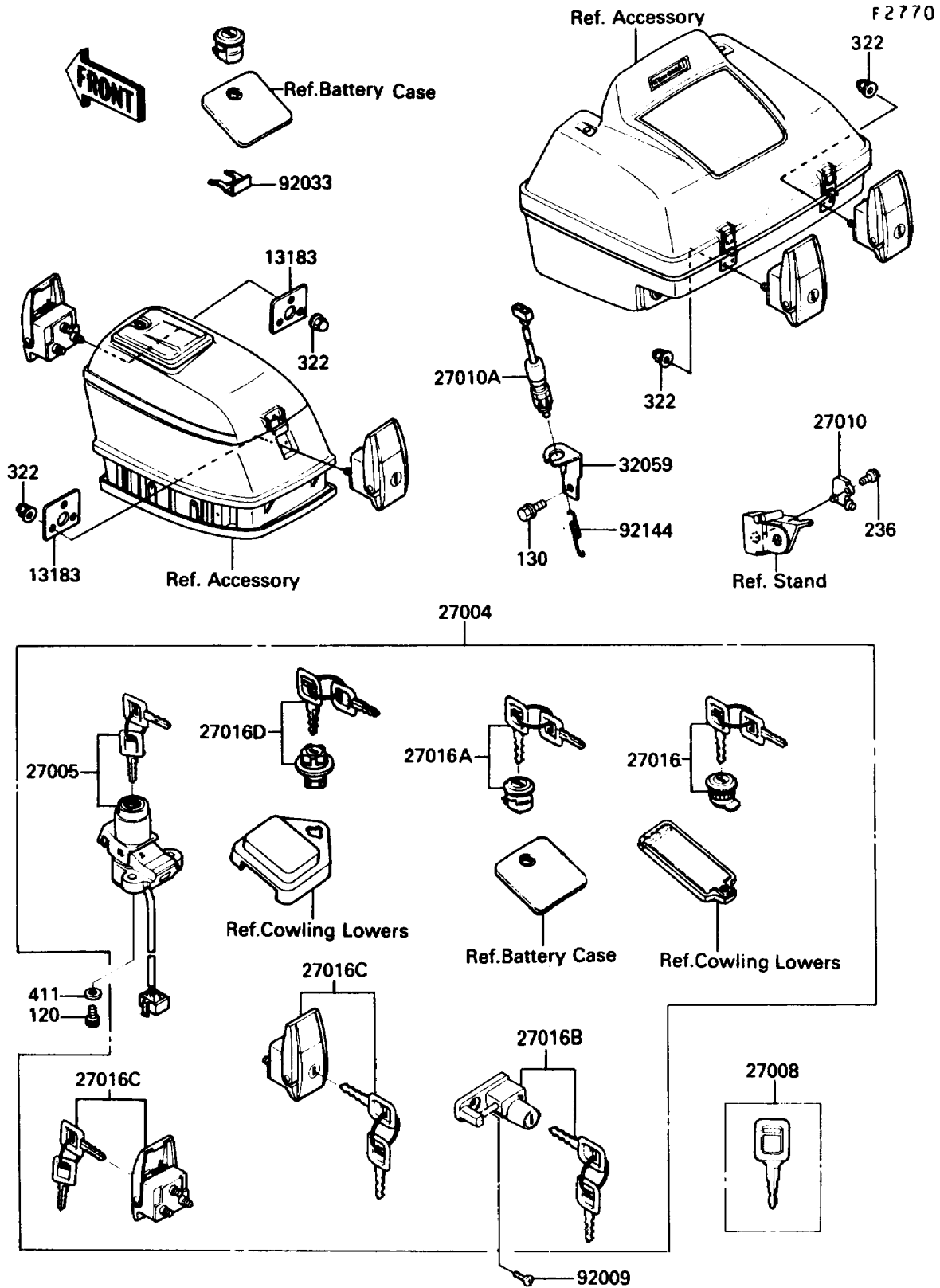

1988 Voyager XII PARTS LIST

Ignition Switch

| ITEM NAME | PART NUMBER | QUANTITY |
|---|-------------|----------|
| BOLT-SOCKET (Ref # 120) | 120T0616 | 2 |
| BOLT-FLANGED (Ref # 130) | 130D0610 | 1 |
| SCREW-PAN-WSP-CROS (Ref # 236) | 236B0416 | 1 |
| NUT-CAP,4MM (Ref # 322) | 322C0400 | 18 |
| WASHER-PLAIN,6MM (Ref # 411) | 411E0600 | 2 |
| PLATE,BAG (Ref # 13183) | 13169-1641 | 4 |
| SWITCH-ASSY (Ref # 27004) | 27004-5318 | 1 |
| SWITCH-ASSY-IGNITION (Ref # 27005) | 27005-5063 | 1 |
| KEY-LOCK,BLANK (Ref # 27008) | 27008-1103 | 1 |
| SWITCH,BRAKE/SIDE STAND (Ref # 27010) | 27010-1185 | 1 |
| SWITCH,REAR BRAKE (Ref # 27010A) | 27010-1200 | 1 |
| LOCK-ASSY (Ref # 27016) | 27016-5105 | 1 |
| LOCK-ASSY,TANK CAP COVER (Ref # 27016A) | 27016-5106 | 1 |
| LOCK-ASSY,HELMET (Ref # 27016B) | 27016-5107 | 2 |
| LOCK-ASSY,BAG (Ref # 27016C) | 27016-5108 | 6 |
| LOCK-ASSY,FAIRING POCKET (Ref # 27016D) | 27016-5128 | 1 |
| BRACKET-SWITCH,REAR BRAKE (Ref # 32059) | 32059-1068 | 1 |
| SCREW,5X12 (Ref # 92009) | 92009-1401 | 2 |
| RING-SNAP,COWLING POCKET (Ref # 92033) | 92033-1095 | 1 |
| SPRING,REAR BRAKE (Ref # 92144) | 92144-1015 | 1 |