

1991 Voyager XII PARTS DIAGRAM

Accessory(Trunk)

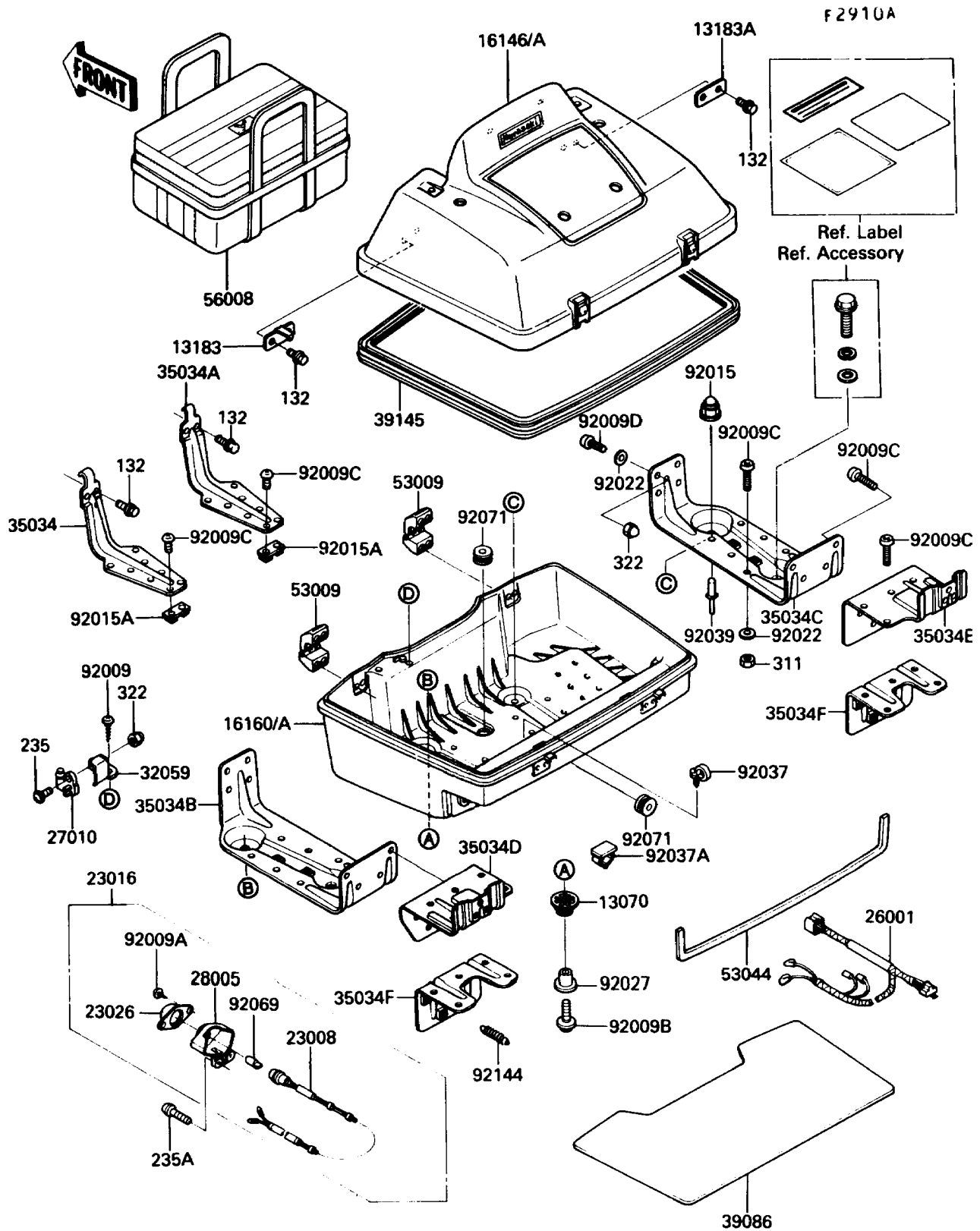

1991 Voyager XII PARTS LIST

Accessory(Trunk)

ITEM NAME	PART NUMBER	QUANTITY
GUIDE (Ref # 13070)	13070-1149	2
PLATE,HINGE,LH (Ref # 13183)	13169-1635	1
PLATE,HINGE,RH (Ref # 13183A)	13169-1636	1
COVER-ASSY,TRUNK,BRONCO/SILVER (Ref # 16146A)	16146-5028-GG	1
BODY,TRUNK,M.C.SILVER (Ref # 16160)	16160-1140-GA	1
SOCKET-ASSY,TRUNK ROOM LAMP (Ref # 23008)	23008-1295	1
LAMP-ASSY,TRUNK ROOM (Ref # 23016)	23016-1066	1
LENS,LAMP (Ref # 23026)	23026-1054	1
HARNESS,TRUNK (Ref # 26001)	26001-1758	1
SWITCH,BRAKE/SIDE STAND (Ref # 27010)	27010-1185	1
BODY-LAMP,TRUNK ROOM (Ref # 28005)	28005-1054	1
BRACKET-SWITCH (Ref # 32059)	32059-1067	1
REINFORCE,HINGE,LH (Ref # 35034)	35034-1213	1
REINFORCE,HINGE,RH (Ref # 35034A)	35034-1214	1
REINFORCE,BAG,LH (Ref # 35034B)	35034-1215	1
REINFORCE,BAG,RH (Ref # 35034C)	35034-1216	1
REINFORCE,TAIL,LH (Ref # 35034D)	35034-1217	1
REINFORCE,TAIL,RH (Ref # 35034E)	35034-1218	1
REINFORCE,TAIL,LWR (Ref # 35034F)	35034-1219	2
PAD-STORAGE,TRUNK (Ref # 39086)	39086-1051	1
TRIM-SEAL,TRUNK (Ref # 39145)	39145-1087	1
HINGE,TRUNK (Ref # 53009)	53009-1071	2
TRIM,TAIL LAMP (Ref # 53044)	53044-1142	1
BAG,INNER (Ref # 56008)	56008-1060	1
SCREW,TAPPING,5X10 (Ref # 92009)	92009-1332	1
SCREW,TAPPING,4X12 (Ref # 92009A)	92009-1381	2
SCREW,6X28,BLACK (Ref # 92009B)	92009-1400	2
SCREW,4X12 (Ref # 92009C)	92009-1448	46
SCREW,4X10 (Ref # 92009D)	92009-1489	8

1991 Voyager XII PARTS LIST

Accessory(Trunk)

ITEM NAME	PART NUMBER	QUANTITY
NUT,LOCK 6MM (Ref # 92015)	92015-1262	2
NUT,PLATE,4MM (Ref # 92015A)	92015-1620	6
WASHER,4.3X12X0.8 (Ref # 92022)	92022-1830	24
COLLAR,L=21 (Ref # 92027)	92027-195	2
CLAMP (Ref # 92037)	92037-1290	2
CLAMP,HARNESS (Ref # 92037A)	92037-1793	1
RIVET (Ref # 92039)	92039-1150	8
BULB,12V 3CP (Ref # 92069)	92069-1066	1
GROMMET (Ref # 92071)	92071-1136	2
BOLT-FLANGED-SMALL,5X12 (Ref # 132)	132J0512	8
SCREW-PAN-WP-CROS (Ref # 235)	235C0414	1
SCREW-PAN-WP-CROS (Ref # 235A)	235C0430	2
NUT-HEX (Ref # 311)	311C0400	12
NUT-CAP,4MM (Ref # 322)	322C0400	9
SPRING,HARNESS GUIDE (Ref # 92144)	92081-1954	1