

1998 Voyager XII PARTS DIAGRAM

Crankshaft

E1321

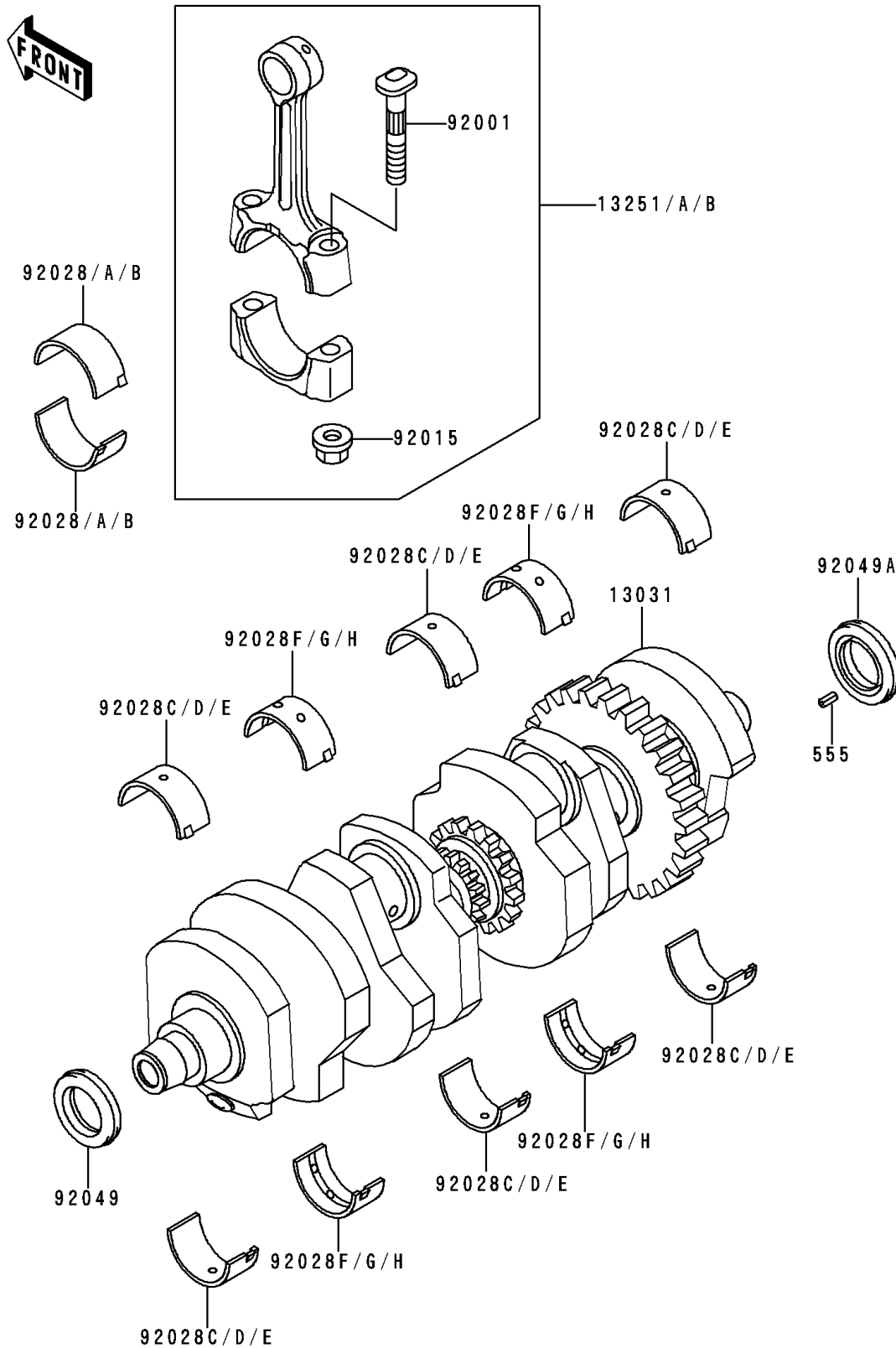

1998 Voyager XII PARTS LIST

Crankshaft

ITEM NAME	PART NUMBER	QUANTITY
PIN-SPRING,4X8 (Ref # 555)	555A0408	1
CRANKSHAFT-COMP (Ref # 13031)	13031-1338	1
ROD-ASSY-CONNECTING,H (Ref # 13251)	13251-1070-HH	4
ROD-ASSY-CONNECTING,I (Ref # 13251A)	13251-1070-II	4
ROD-ASSY-CONNECTING,J (Ref # 13251B)	13251-1070-JJ	4
BOLT,CONNECTING ROD (Ref # 92001)	92001-1980	8
NUT,FLANGED,8MM (Ref # 92015)	92015-1311	8
BUSHING,CONNECTING ROD,BLUE (Ref # 92028)	92028-1394	AR
BUSHING,CONNECTING ROD,BLACK (Ref # 92028A)	92028-1395	AR
BUSHING,CONNECTING ROD,BROWN (Ref # 92028B)	92028-1396	AR
BUSHING,CRANKSHAFT,BLUE (Ref # 92028C)	92028-1455	AR
BUSHING,CRANKSHAFT,BLACK (Ref # 92028D)	92028-1456	AR
BUSHING,CRANKSHAFT,BROWN (Ref # 92028E)	92028-1457	AR
BUSHING,CRANKSHAFT,BLUE (Ref # 92028F)	92028-1458	AR
BUSHING,CRANKSHAFT,BLACK (Ref # 92028G)	92028-1459	AR
BUSHING,CRANKSHAFT,BROWN (Ref # 92028H)	92028-1460	AR
SEAL-OIL,HSCY28417 (Ref # 92049)	92049-1246	1
SEAL-OIL,HSCY25417 (Ref # 92049A)	92049-1247	1