

# 2013 KLX® 250S PARTS DIAGRAM

## Chassis Electrical Equipment

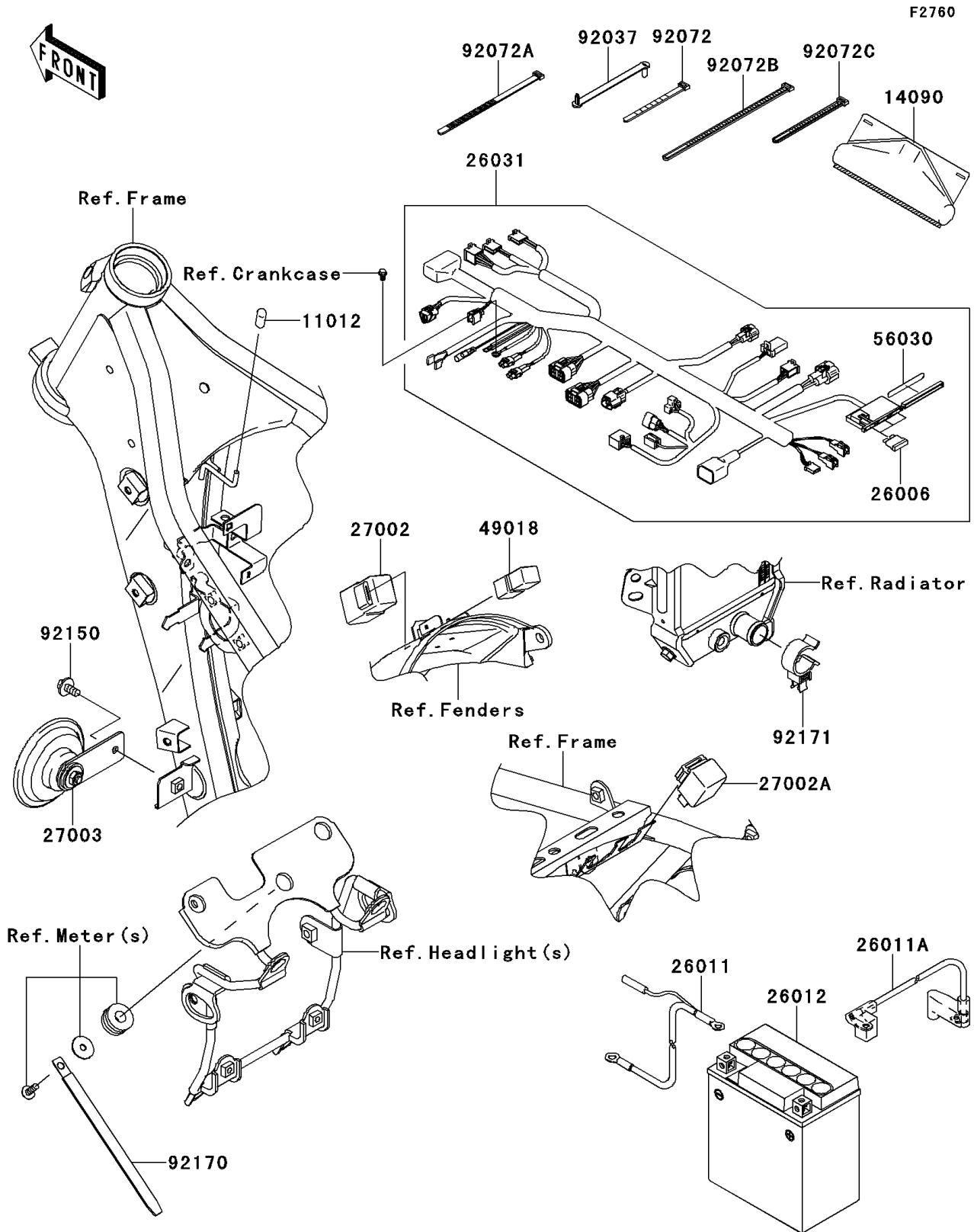

## 2013 KLX® 250S PARTS LIST

### Chassis Electrical Equipment

ITEM NAME	PART NUMBER	QUANTITY
CAP,BUNGEE CORD HOOK (Ref # 11012)	11012-1589	1
COVER,COUPLER (Ref # 14090)	14090-1331	1
FUSE,MINI BLADE,10A,RED (Ref # 26006)	26006-0009	3
WIRE-LEAD,BATTERY(-) (Ref # 26011)	26011-0209	1
WIRE-LEAD,BATTERY(+) (Ref # 26011A)	26011-1609	1
BATTERY,FTX7L-BS,12V6AH (Ref # 26012)	26012-0070	1
HARNESS,MAIN (Ref # 26031)	26031-0721	1
RELAY-ASSY (Ref # 27002)	27002-1086	1
RELAY-ASSY,SIGNAL LAMP (Ref # 27002A)	27002-1097	1
HORN (Ref # 27003)	27003-0029	1
DIODE (Ref # 49018)	49018-0005	1
LABEL,FUSE BOX (Ref # 56030)	56030-0192	1
CLAMP,SPEED,L=58 (Ref # 92037)	92037-1163	3
BAND,L=123 (Ref # 92072)	92072-030	1
BAND,L=202 (Ref # 92072A)	92072-1195	1
BAND,L=250 (Ref # 92072B)	92072-1237	4
BAND,L=140 (Ref # 92072C)	92072-1293	3
BOLT,FLANGED,6X14 (Ref # 92150)	92150-1689	1
CLAMP,L=150 (Ref # 92170)	92170-1114	1
CLAMP (Ref # 92171)	92171-1437	1