

2023 Z900 ABS PARTS DIAGRAM

Accessory(Slider)

F2910E

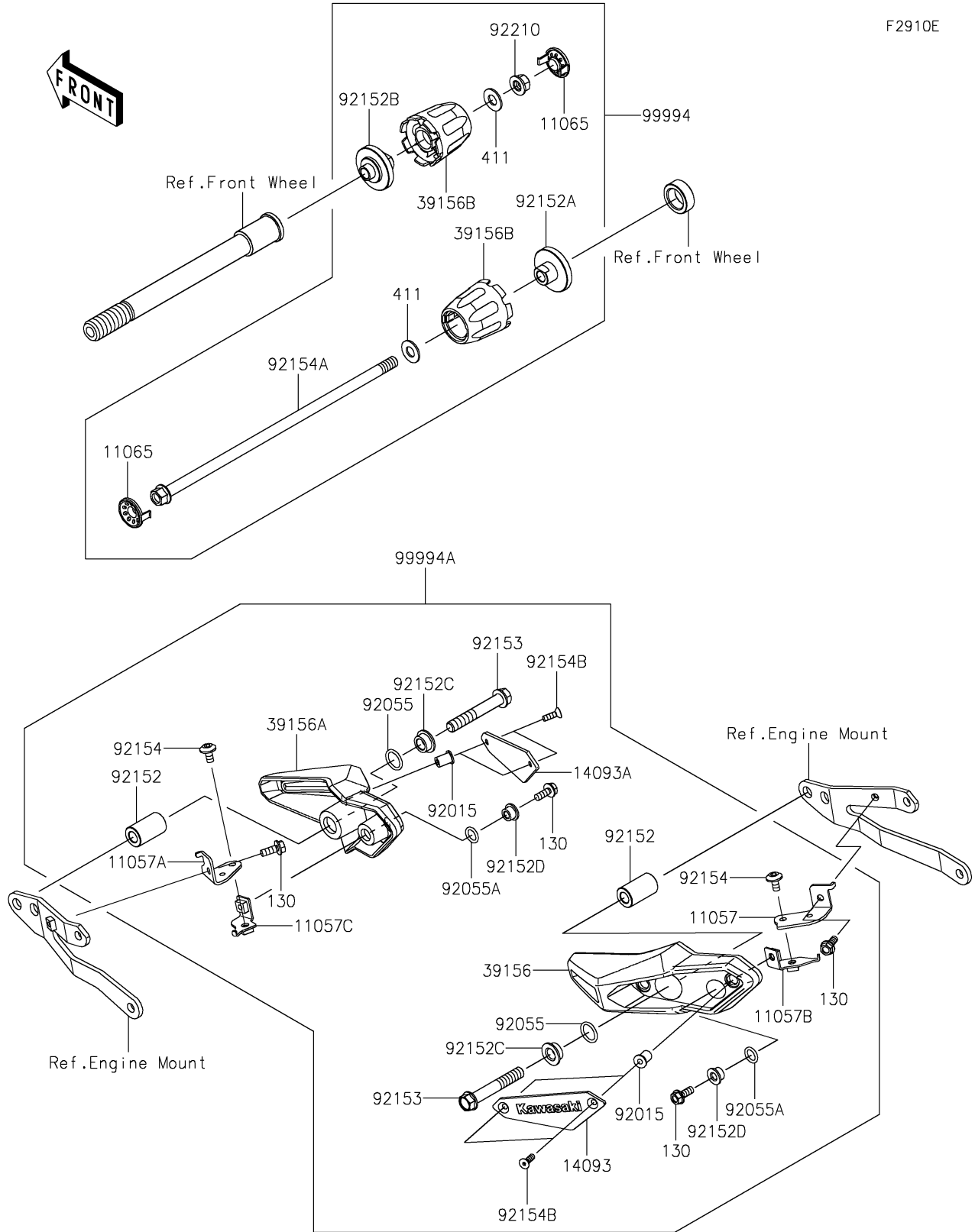

2023 Z900 ABS PARTS LIST

Accessory(Slider)

ITEM NAME	PART NUMBER	QUANTITY
BRACKET,LH (Ref # 11057)	11057-2712	1
BRACKET,RH (Ref # 11057A)	11057-2713	1
BRACKET,LH,FR (Ref # 11057B)	11057-2714	1
BRACKET,RH,FR (Ref # 11057C)	11057-2715	1
CAP,B.SILVER (Ref # 11065)	11065-1313-54N	2
COVER,LH (Ref # 14093)	14093-0516	1
COVER,RH (Ref # 14093A)	14093-0517	1
PAD,LH (Ref # 39156)	39156-2123	1
PAD,RH (Ref # 39156A)	39156-2124	1
PAD,AXLE SLIDER (Ref # 39156B)	39156-2212	2
NUT,WELL,5MM (Ref # 92015)	92015-1757	4
RING-O,15.8X2.4 (Ref # 92055)	92055-0884	2
RING-O,11X2.4 (Ref # 92055A)	92055-0885	2
COLLAR,10.5X20X34 (Ref # 92152)	92152-2268	2
COLLAR,LH (Ref # 92152A)	92152-2272	1
COLLAR,RH (Ref # 92152B)	92152-2273	1
COLLAR,10.5X22X8.1 (Ref # 92152C)	92152-2334	2
COLLAR,6.5X16X8.1 (Ref # 92152D)	92152-2335	2
BOLT,FLANGED,10X65 (Ref # 92153)	92153-1931	2
BOLT,SOCKET,6X12 (Ref # 92154)	92154-1788	2
BOLT,AXLE,10X300 (Ref # 92154A)	92154-2250	1
BOLT,SOCKET,5X16 (Ref # 92154B)	92154-2669	4
NUT,LOCK,FLANGED,10MM (Ref # 92210)	92210-1139	1
KIT-ACCESSORY,FR AXLE SLIDER (Ref # 99994)	99994-1275	1
FRAME SLIDER (Ref # 99994A)	99994-1350	1
BOLT-FLANGED,6X16 (Ref # 130)	130CB0616	4
WASHER-PLAIN,10MM (Ref # 411)	411AA1000	2