

2024 Z900 SE PARTS DIAGRAM

Accessory(USB Socket)

F2910B

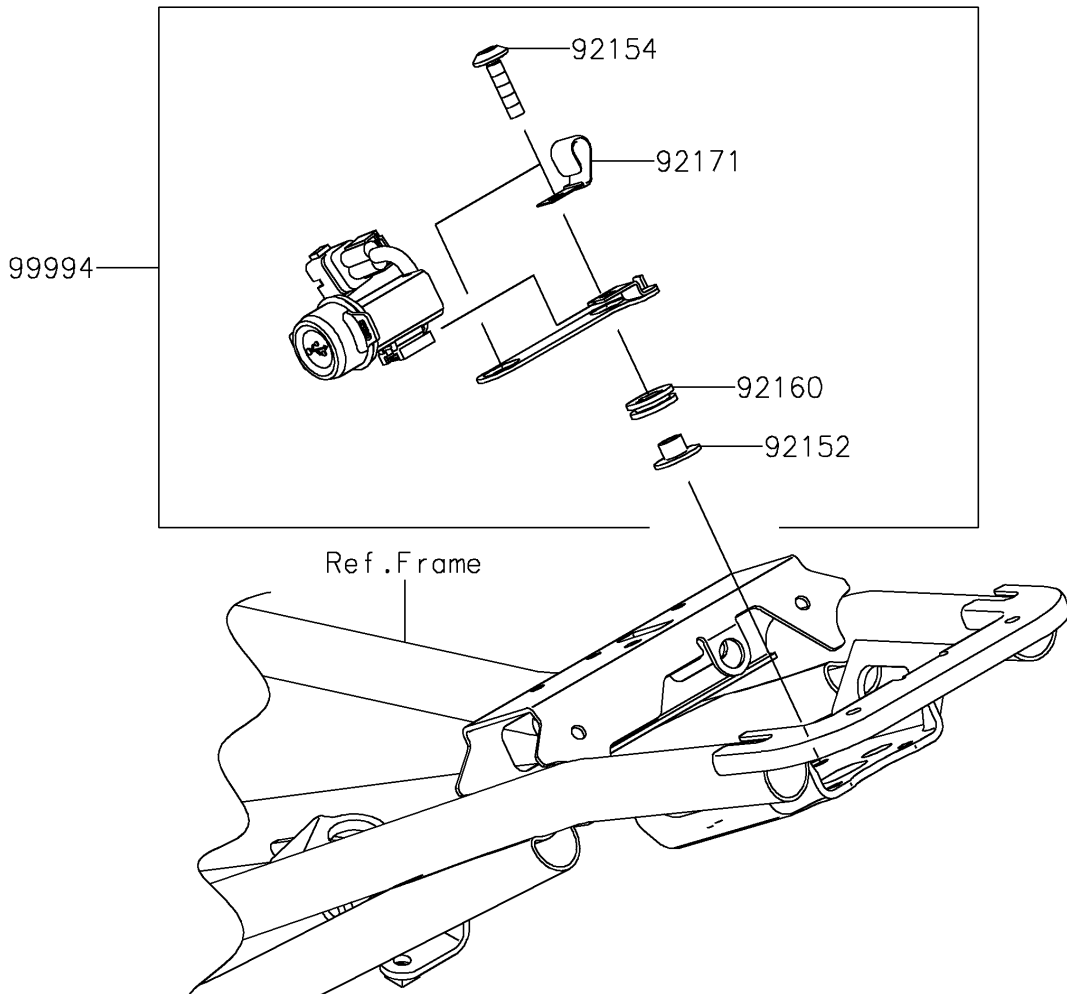

2024 Z900 SE PARTS LIST

Accessory(USB Socket)

ITEM NAME	PART NUMBER	QUANTITY
COLLAR (Ref # 92152)	92152-0181	2
BOLT,SOCKET,6X25 (Ref # 92154)	92154-1629	2
DAMPER (Ref # 92160)	92160-1278	2
CLAMP,L=60 (Ref # 92171)	92171-0652	1
USB-SOCKET KIT (Ref # 99994)	99994-1353	1