

1999 Voyager XII PARTS DIAGRAM

Handlebar

F2310

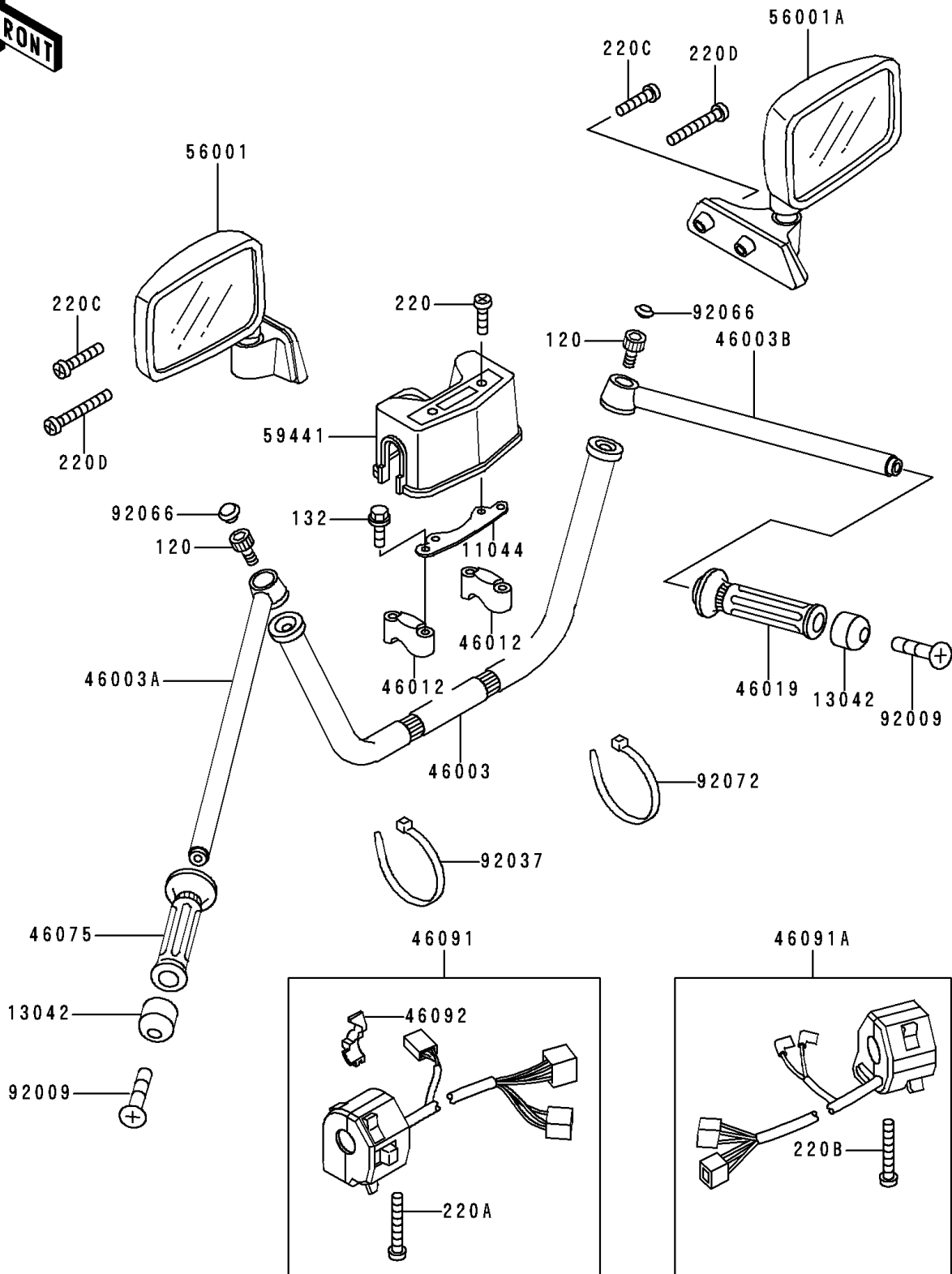

1999 Voyager XII PARTS LIST

Handlebar

ITEM NAME	PART NUMBER	QUANTITY
BOLT-SOCKET (Ref # 120)	120T1025	2
BOLT-FLANGED-SMALL (Ref # 132)	132G0840	4
SCREW-PAN-CROS (Ref # 220)	220C0416	2
SCREW-PAN-CROS (Ref # 220A)	220C0545	2
SCREW-PAN-CROS,5X50 (Ref # 220B)	220C0550	2
SCREW-PAN-CROS,6X30,BLACK (Ref # 220C)	220C0630	2
SCREW-PAN-CROS,6X45,BLACK (Ref # 220D)	220C0645	2
BRACKET,HANDLE COVER (Ref # 11044)	11044-1635	1
WEIGHT,HANDLE (Ref # 13042)	13042-1051	2
HANDLE,CNT (Ref # 46003)	46003-1210	1
HANDLE,LH (Ref # 46003A)	46003-1211	1
HANDLE,RH (Ref # 46003B)	46003-1212	1
HOLDER-HANDLE,UPP (Ref # 46012)	46012-1151	2
GRIP-ASSY,THROTTLE (Ref # 46019)	46019-1064	1
GRIP,LH (Ref # 46075)	46075-1068	1
HOUSING-ASSY-CONTROL,LH (Ref # 46091)	46091-1385	1
HOUSING-ASSY-CONTROL,RH (Ref # 46091A)	46091-1452	1
LEVER-GRIP,CHOKE (Ref # 46092)	46092-1124	1
MIRROR-ASSY,LH (Ref # 56001)	56001-1262	1
MIRROR-ASSY,RH (Ref # 56001A)	56001-1263	1
COVER-HANDLE (Ref # 59441)	59441-1065	1
SCREW,8X45 (Ref # 92009)	92009-1257	2
CLAMP,BAND,L=137 (Ref # 92037)	92037-1817	4
PLUG,18.3X4.5 (Ref # 92066)	92066-1234	2
BAND,L=185 (Ref # 92072)	92072-1195	2