

1999 Voyager XII PARTS DIAGRAM

Cables

F2540

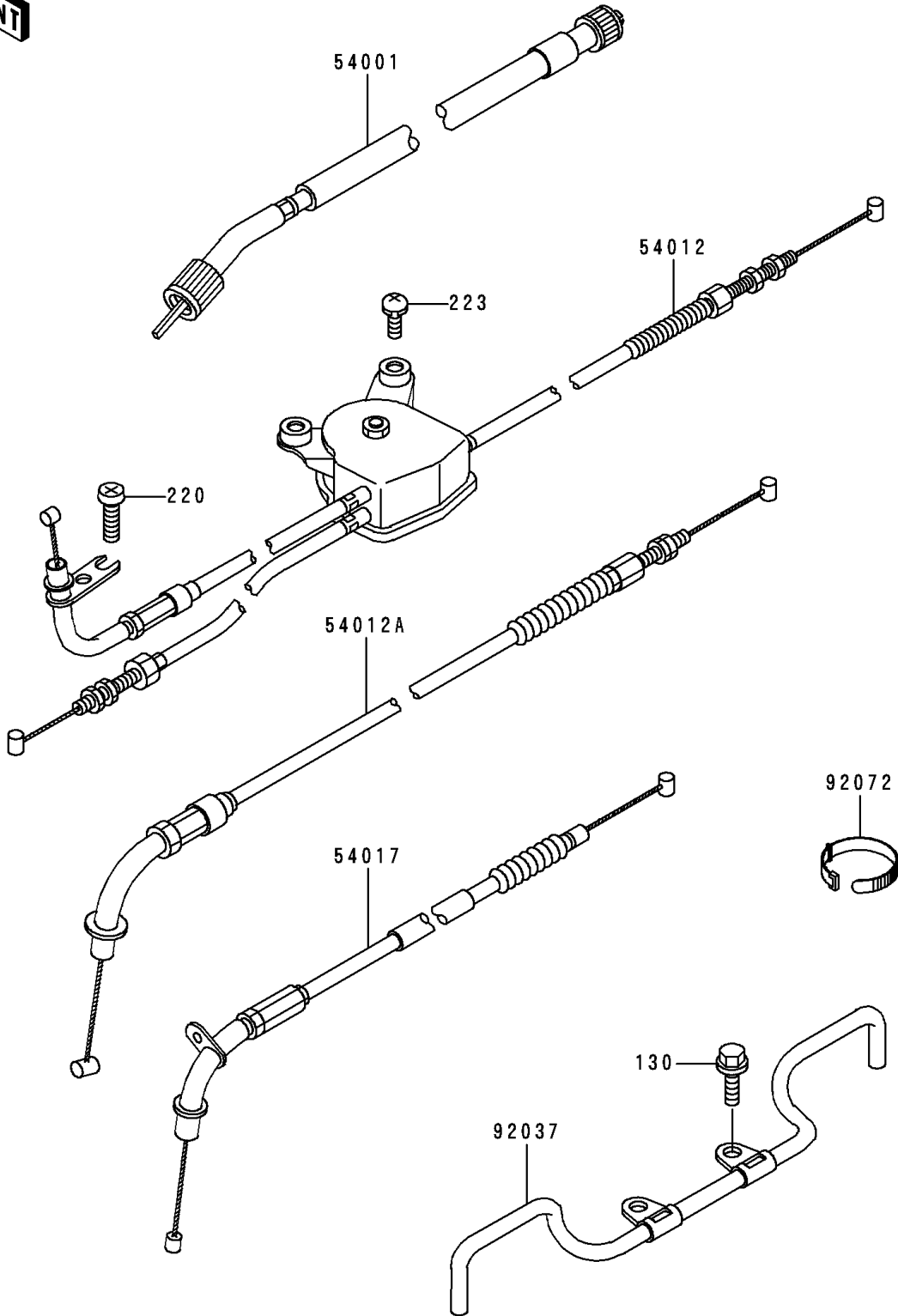

1999 Voyager XII PARTS LIST

Cables

ITEM NAME	PART NUMBER	QUANTITY
BOLT-FLANGED (Ref # 130)	130B0614	2
SCREW-PAN-CROS (Ref # 220)	220C0514	1
SCREW-PAN-WS-CROS (Ref # 223)	223B0610	2
CABLE-SPEEDOMETER (Ref # 54001)	54001-1121	1
CABLE-THROTTLE,OPENING (Ref # 54012)	54012-1331	1
CABLE-THROTTLE,CLOSING (Ref # 54012A)	54012-1332	1
CABLE-STARTER (Ref # 54017)	54017-1095	1
CLAMP,CABLE&HOSE (Ref # 92037)	92037-1832	1
BAND,L=185 (Ref # 92072)	92072-1195	1