

2000 Voyager XII PARTS DIAGRAM

Chassis Electrical Equipment

F2760

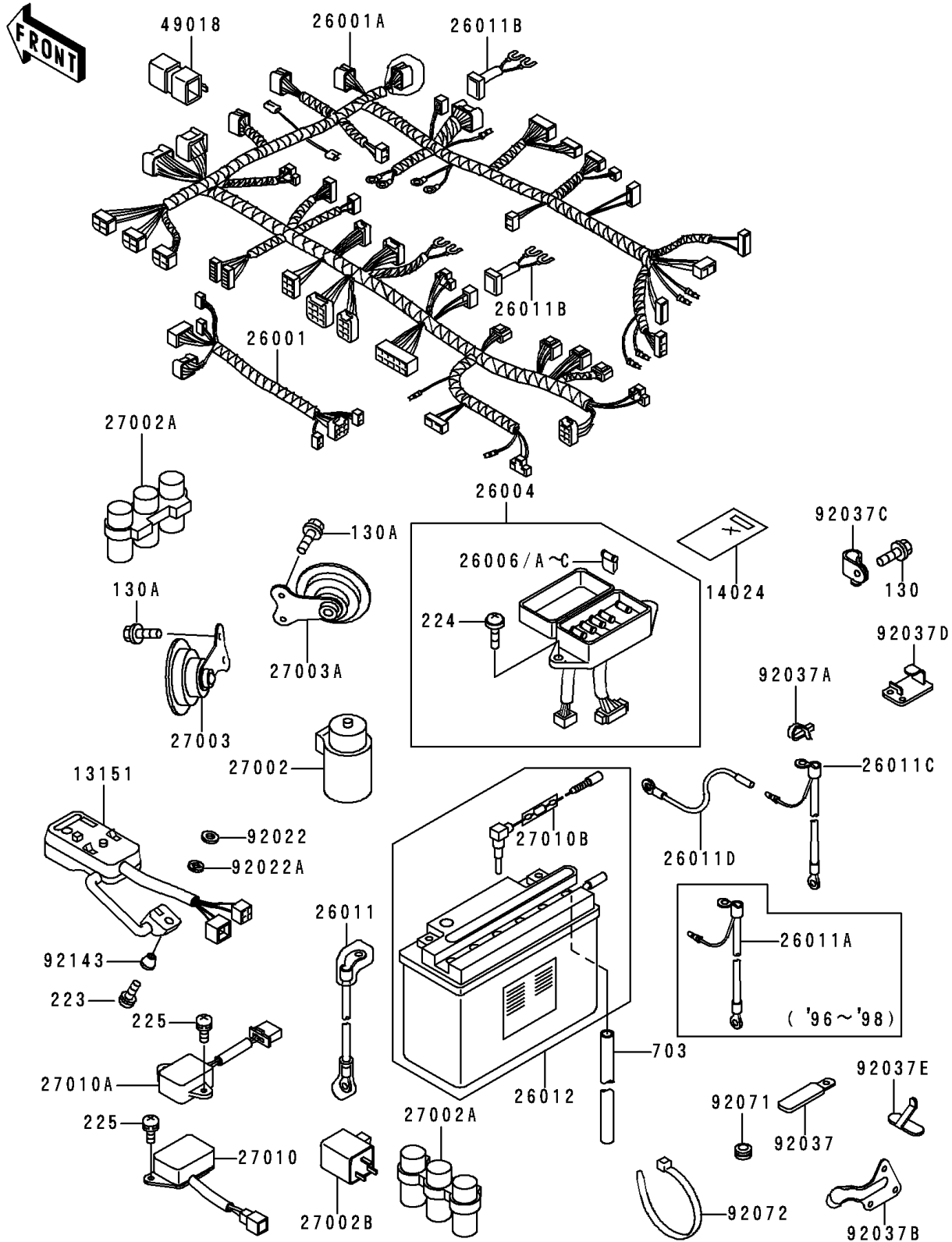

2000 Voyager XII PARTS LIST

Chassis Electrical Equipment

ITEM NAME	PART NUMBER	QUANTITY
BOLT-FLANGED,6X10 (Ref # 130)	130B0610	2
BOLT-FLANGED,6X12 (Ref # 130A)	130C0612	4
SCREW-PAN-WS-CROS (Ref # 223)	223C0620	1
SCREW-PAN-WP-CROS (Ref # 224)	224B0614	2
SCREW-PAN-WSP-CROS (Ref # 225)	225B0620	4
SWITCH-COMP,AUDIO (Ref # 13151)	13151-1063	1
COVER,HARNESS (Ref # 14024)	14024-1352	1
HARNESS,RADIO (Ref # 26001)	26001-1863	1
HARNESS,MAIN (Ref # 26001A)	26001-1892	1
FUSE-ASSY (Ref # 26004)	26004-1085	1
FUSE,30A-G (Ref # 26006)	26006-1067	2
FUSE,10A-R (Ref # 26006A)	26006-1068	6
FUSE,15A-B (Ref # 26006B)	26006-1069	2
FUSE,3A-P (Ref # 26006C)	26006-1070	1
WIRE-LEAD,BATTERY(+) (Ref # 26011)	26011-1339	1
WIRE-LEAD,IGNITION COIL (Ref # 26011B)	26011-1365	2
WIRE-LEAD,BATTERY(-) (Ref # 26011C)	26011-1705	1
WIRE-LEAD,THERMO SENSER (Ref # 26011D)	26011-1706	1
BATTERY,12V 20AH,SY50-N18L-A (Ref # 26012)	26012-1240	1
RELAY-ASSY (Ref # 27002)	27002-1051	1
RELAY-ASSY (Ref # 27002A)	27002-1052	2
RELAY-ASSY,TURN SIGNAL (Ref # 27002B)	27002-1060	1
HORN,350HZ,LH (Ref # 27003)	27003-1239	1
HORN,415HZ,RH (Ref # 27003A)	27003-1240	1
SWITCH,RESERVE LIGHTING (Ref # 27010)	27010-1069	1
SWITCH,TURN SIGNAL OPERATION (Ref # 27010A)	27010-1166	1
SWITCH,BATTERY,L=180 (Ref # 27010B)	27010-1256	1
DIODE (Ref # 49018)	49018-1052	2
WASHER,6.5X20X1.6 (Ref # 92022)	92022-125	1

2000 Voyager XII PARTS LIST

Chassis Electrical Equipment

ITEM NAME	PART NUMBER	QUANTITY
WASHER,WAVE,10MM (Ref # 92022A)	92022-1828	1
CLAMP,WIRING HARNESS,L=60 (Ref # 92037)	92037-1069	6
CLAMP,SPEED,L=58 (Ref # 92037A)	92037-1163	1
CLAMP (Ref # 92037B)	92037-1720	1
CLAMP,HOSE (Ref # 92037C)	92037-1727	1
CLAMP,HARNESS (Ref # 92037D)	92037-1816	1
CLAMP,HARNESS (Ref # 92037E)	92037-1820	3
GROMMET (Ref # 92071)	92071-024	1
BAND,L=185 (Ref # 92072)	92072-1195	12
COLLAR (Ref # 92143)	92143-1026	1
TUBE-RUBBER,8X750 (Ref # 703)	703A08750	1