

1996 Voyager XII PARTS DIAGRAM

Owner's Tools

56007

F2810

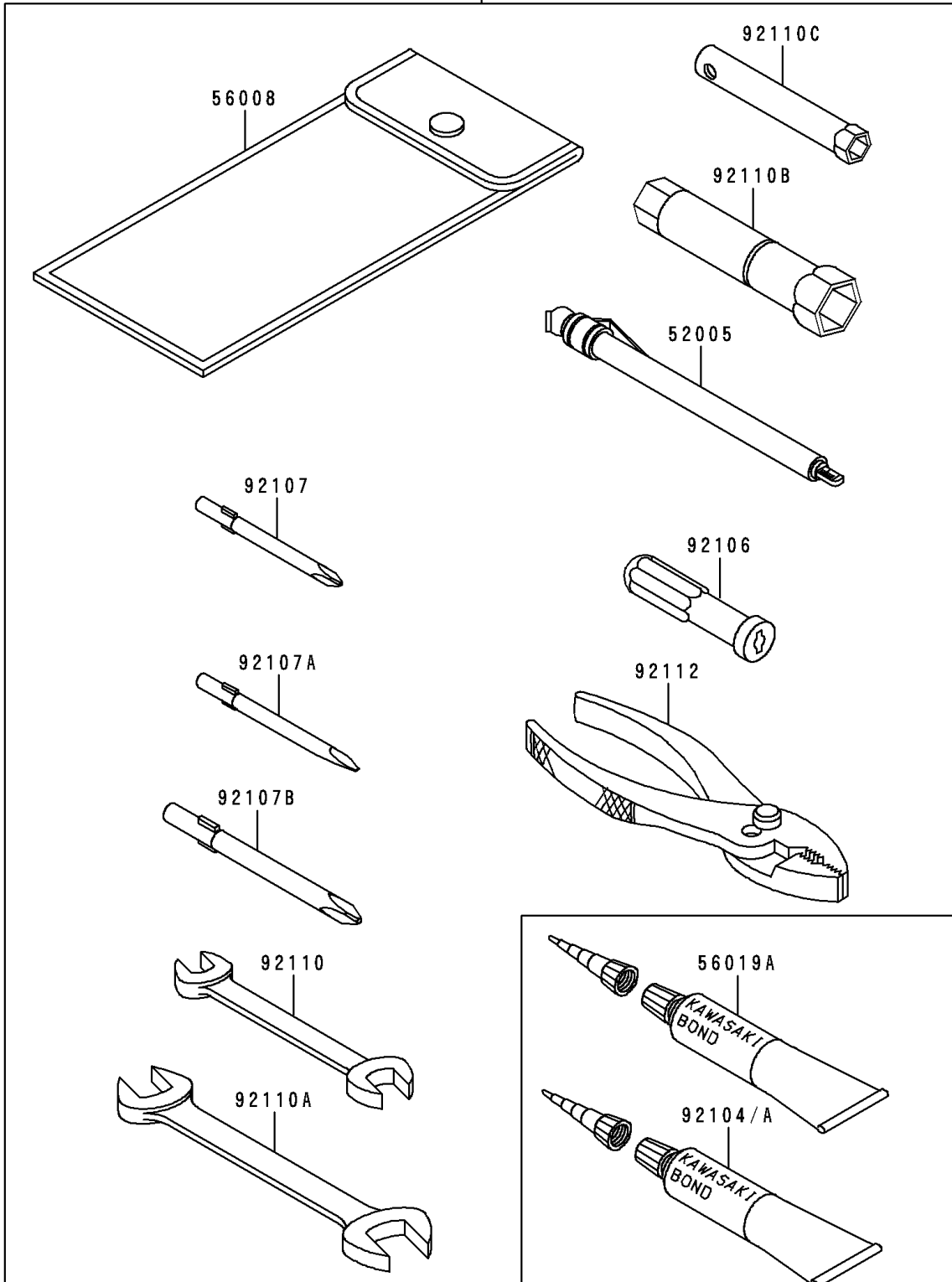

1996 Voyager XII PARTS LIST

Owner's Tools

ITEM NAME	PART NUMBER	QUANTITY
GAUGE,AIR,3.5KG/CM2 (Ref # 52005)	52005-1031	1
TOOLKIT (Ref # 56007)	56007-1236	1
BAG,TOOL (Ref # 56008)	56008-006	1
THREE BOND TB1211,HT/RS,WHITE (Ref # 56019A)	56019-120	1
GASKET-LIQUID,TUBE,100G,SILVER (Ref # 92104)	92104-002	1
GASKET-LIQUID,SILVER TB1216 (Ref # 92104A)	92104-1063	AR
GRIP-SCREW DRIVER (Ref # 92106)	92106-1001	1
TOOL-DRIVER,#2PHILLIPS (Ref # 92107)	92107-006	1
TOOL-DRIVER,#2SLOT (Ref # 92107A)	92107-007	1
TOOL-DRIVER,#3PHILLIPS (Ref # 92107B)	92107-008	1
TOOL-WRENCH,OPEN END,10X12 (Ref # 92110)	92110-1038	1
TOOL-WRENCH,OPEN END,14X17 (Ref # 92110A)	92110-1045	1
TOOL-WRENCH,BOX,17X18 (Ref # 92110B)	92110-1124	1
TOOL-WRENCH,BOX,10MM (Ref # 92110C)	92110-1125	1
TOOL-PLIERS (Ref # 92112)	92112-003	1