

2003 Voyager XII PARTS DIAGRAM

Seat

F2510

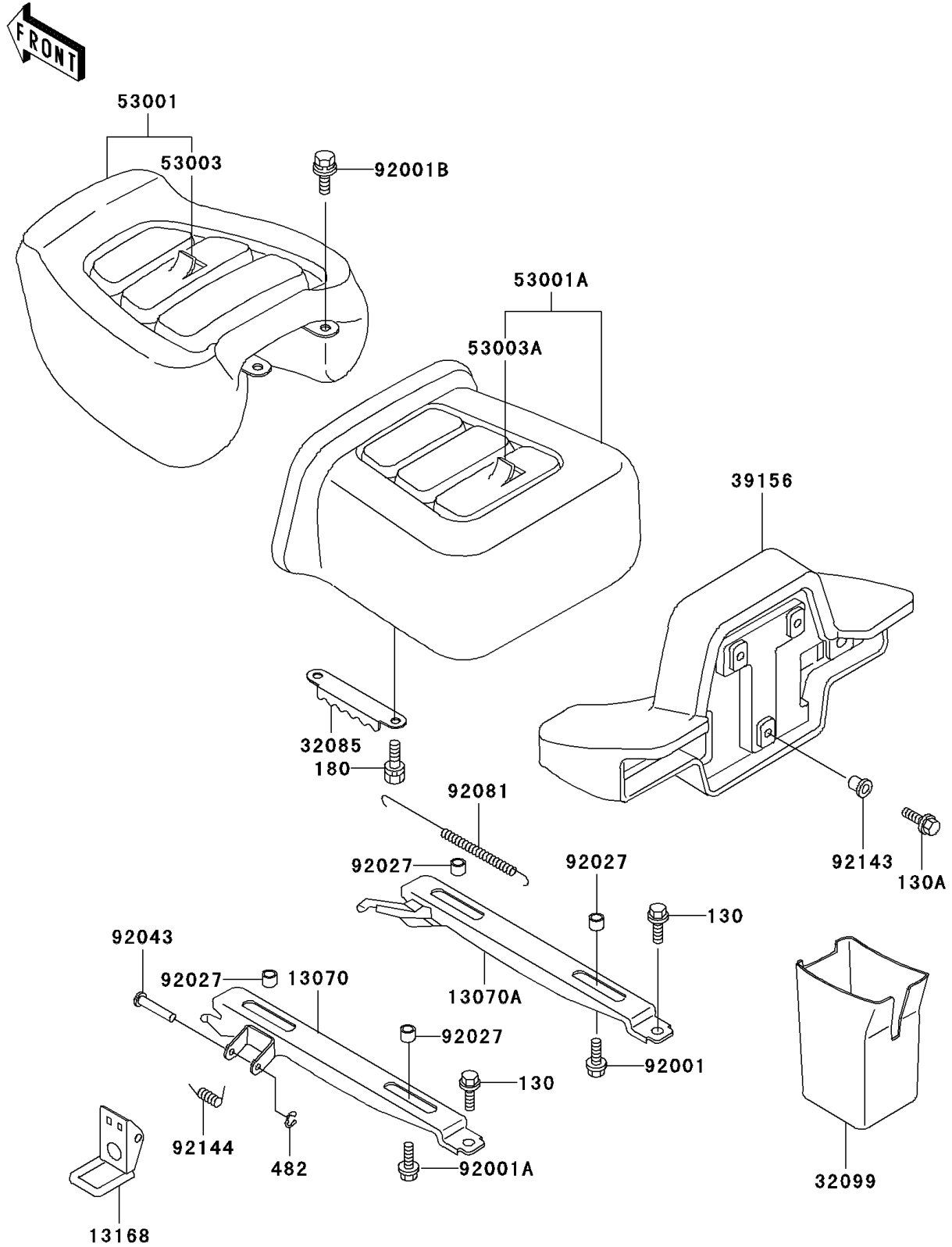

2003 Voyager XII PARTS LIST

Seat

ITEM NAME	PART NUMBER	QUANTITY
BOLT-FLANGED,6X10 (Ref # 130)	130B0610	2
BOLT-FLANGED,6X20 (Ref # 130A)	130C0620	7
BOLT-UPSET-WS,6X12 (Ref # 180)	180B0612	2
CIRCLIP-TYPE-E,5MM (Ref # 482)	482L5000	1
GUIDE,REAR SEAT,LH (Ref # 13070)	13070-1147	1
GUIDE,REAR SEAT,RH (Ref # 13070A)	13070-1148	1
LEVER,REAR SEAT (Ref # 13168)	13168-1302	1
STOPPER,SEAT (Ref # 32085)	32085-1248	1
CASE,REAR AUDIO CONTROL,GRAY (Ref # 32099)	32099-1091-PP	1
PAD,SEAT,GRAY 10 (Ref # 39156)	39156-1401-PP	1
SEAT-ASSY,FR,GRAY 10 (Ref # 53001)	53001-1743-PP	1
SEAT-ASSY,RR,GRAY 10 (Ref # 53001A)	53001-1744-PP	1
LEATHER,FRONT SEAT,GRAY 10 (Ref # 53003)	53003-1291-PP	1
LEATHER,REAR SEAT,GRAY 10 (Ref # 53003A)	53003-1292-PP	1
BOLT,6X20 (Ref # 92001)	92001-1826	2
BOLT,W/P,6X16 (Ref # 92001A)	92001-1860	2
BOLT,W/SP,6X14 (Ref # 92001B)	92001-1862	2
COLLAR,6.3X10X5 (Ref # 92027)	92027-164	4
PIN,6X35.3 (Ref # 92043)	92043-1109	1
SPRING,SEAT RETURN (Ref # 92081)	92081-1950	1
COLLAR,L=6.5 (Ref # 92143)	92143-1025	7
SPRING,SEAT LEVER (Ref # 92144)	92144-1038	1