

# 2023 Ninja ZX-6R (CA) PARTS DIAGRAM

Chain Cover

F2650

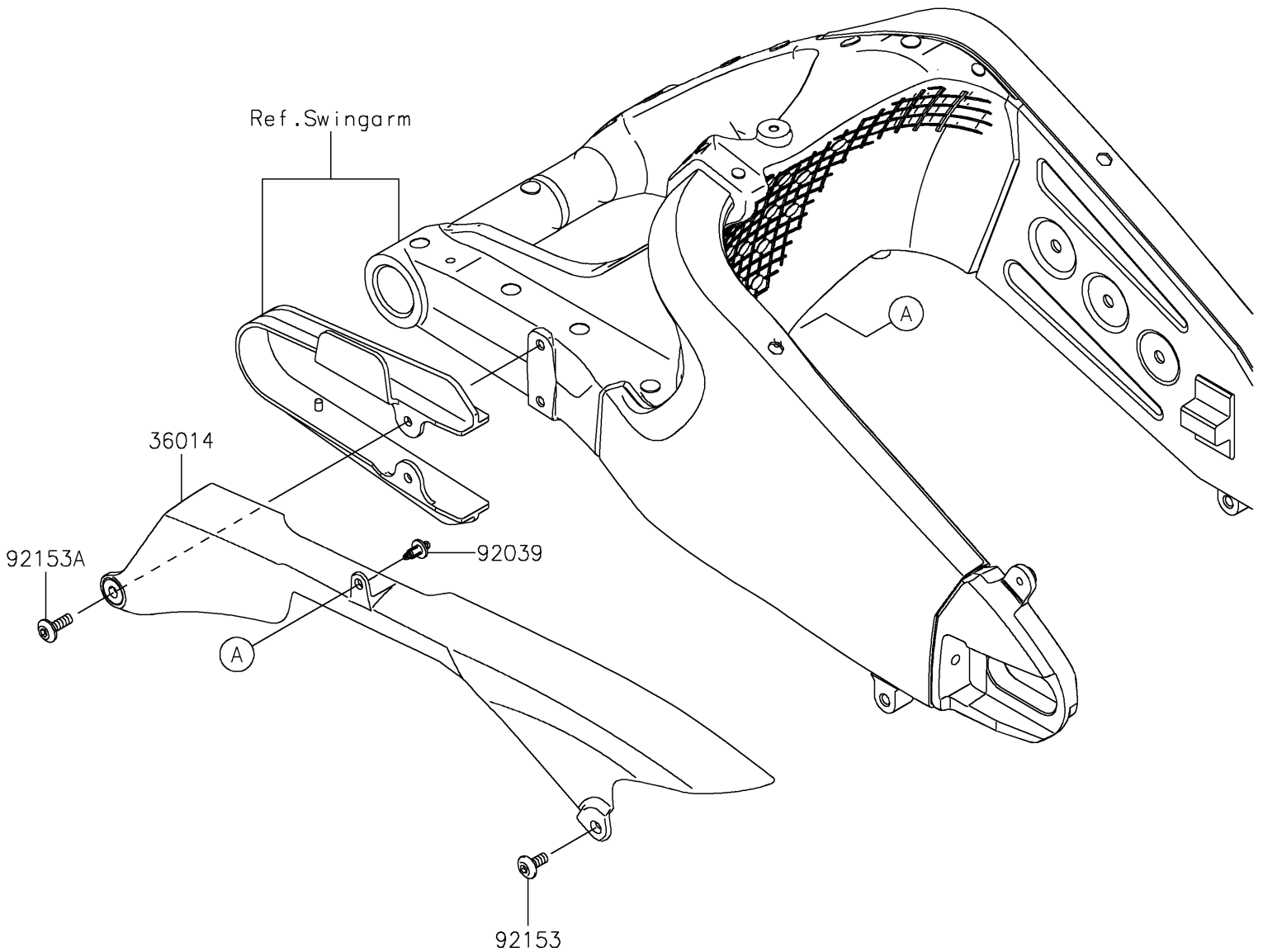

## 2023 Ninja ZX-6R (CA) PARTS LIST

### Chain Cover

ITEM NAME	PART NUMBER	QUANTITY
CASE-CHAIN (Ref # 36014)	36014-0048	1
RIVET (Ref # 92039)	92039-0068	1
BOLT,SOCKET,6X14 (Ref # 92153)	92153-0422	1
BOLT,SOCKET,6X18 (Ref # 92153A)	92153-1675	1