

1993 Voyager XII PARTS DIAGRAM

Fuel Tank

F2410

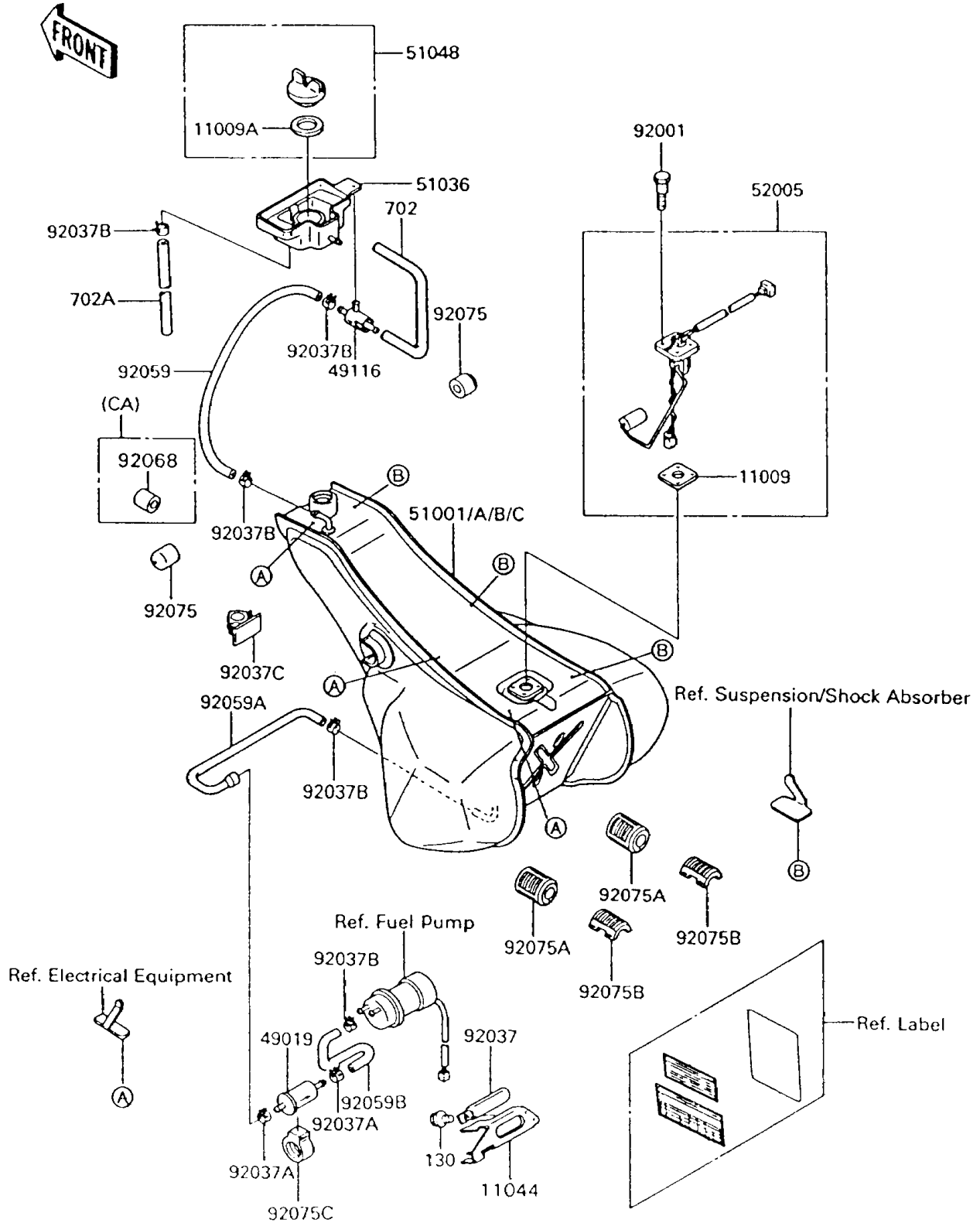

1993 Voyager XII PARTS LIST

Fuel Tank

ITEM NAME	PART NUMBER	QUANTITY
BOLT-FLANGED,6X10 (Ref # 130)	130B0610	2
TUBE-RUBBER,7X720 (Ref # 702A)	702A07720	1
GASKET,TANK CAP (Ref # 11009)	11009-1326	1
GASKET,FUEL GAUGE (Ref # 11009A)	11009-1656	1
BRACKET,FUEL FILTER (Ref # 11044)	11044-1743	1
FILTER-FUEL (Ref # 49019)	49019-1055	1
VALVE-ASSY,BREATHER (Ref # 49116)	49116-1063	1
CUP,FUEL TANK (Ref # 51036)	51036-1054	1
CAP-ASSY-TANK,FUEL (Ref # 51048)	51048-1070	1
GAUGE,FUEL (Ref # 52005)	52005-1076	1
BOLT,FUEL GAUGE (Ref # 92001)	92001-1705	4
CLAMP,WIRING HARNESS (Ref # 92037)	92037-1069	1
CLAMP (Ref # 92037A)	92037-1181	2
CLAMP,TUBE (Ref # 92037B)	92037-1505	5
CLAMP,TUBE (Ref # 92037C)	92037-1794	2
TUBE,5.8X11.5X260 (Ref # 92059)	92059-1392	1
TUBE (Ref # 92059A)	92059-1724	1
TUBE (Ref # 92059B)	92059-1725	1
DAMPER,FUEL TANK (Ref # 92075)	92075-044	2
DAMPER,FUEL TANK (Ref # 92075A)	92075-084	2
DAMPER,FUEL TANK (Ref # 92075B)	92075-1806	2
DAMPER,FUEL FILTER (Ref # 92075C)	92075-1853	1
TUBE-RUBBER,5X170 (Ref # 702)	702A05170	1
TANK-COMP-FUEL (Ref # 51001)	51001-1233	1
TANK-COMP-FUEL (Ref # 51001A)	51001-1239	1
PLUG,12X25 (Ref # 92068)	92068-006	1