

1995 Voyager XII PARTS DIAGRAM

Taillight(s)

F2720

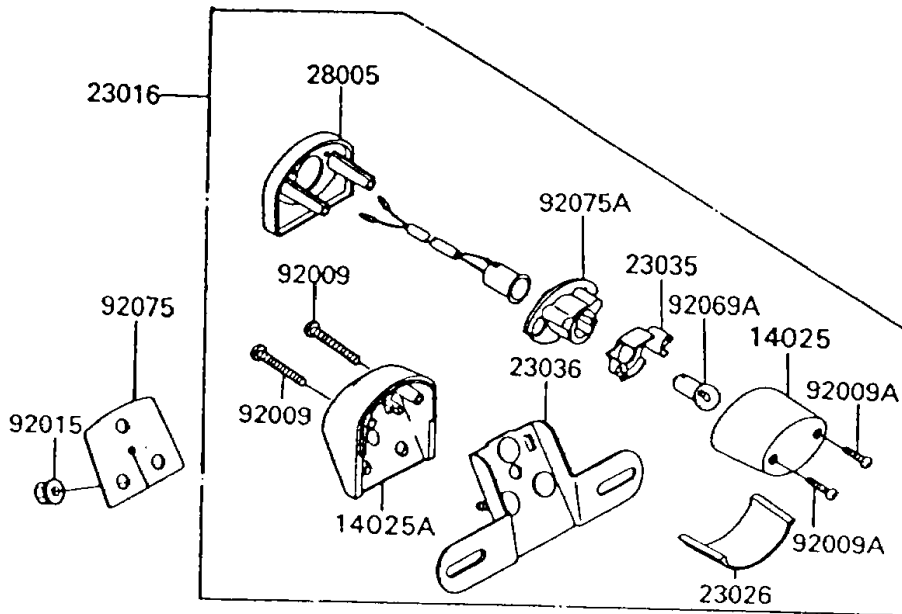
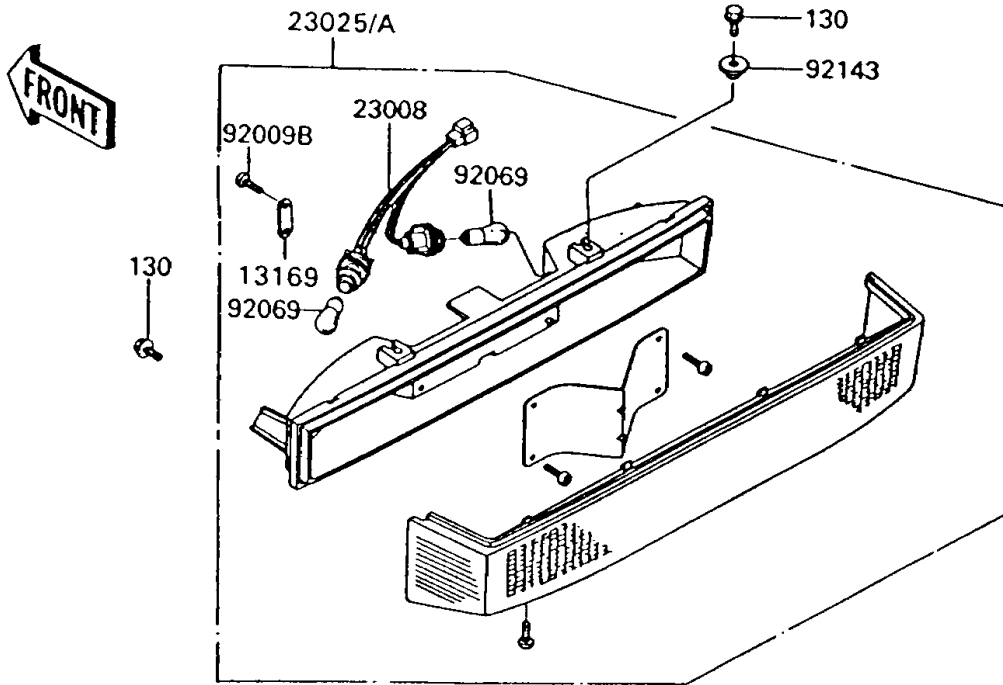

1995 Voyager XII PARTS LIST

Taillight(s)

ITEM NAME	PART NUMBER	QUANTITY
BOLT-FLANGED,6X20 (Ref # 130)	130C0620	4
PLATE,TAIL LAMP (Ref # 13169)	13169-1680	1
COVER,LICENSE LAMP (Ref # 14025)	14025-1725	1
COVER,LICENSE LAMP (Ref # 14025A)	14025-1728	1
SOCKET-ASSY,TAIL LAMP (Ref # 23008)	23008-1300	1
LAMP-ASSY,LICENSE (Ref # 23016)	23016-1062	1
LAMP-TAIL,P.T.GREEN (Ref # 23025A)	23025-1180-SM	1
LENS,LICENSE LAMP (Ref # 23026)	23026-1064	1
REFLECTOR-LAMP,LICENSE (Ref # 23035)	23035-1060	1
BRACKET-TAIL LAMP (Ref # 23036)	23036-1105	1
BODY-LAMP,LICENSE (Ref # 28005)	28005-1051	1
SCREW,TAPPING,5X40 (Ref # 92009)	92009-1263	2
SCREW,TAPPING,4X20 (Ref # 92009A)	92009-1378	2
SCREW,TAPPING,4X12 (Ref # 92009B)	92009-1395	1
NUT,FLANGED,6MM (Ref # 92015)	92015-1367	3
BULB,12V 27/8W (Ref # 92069)	92069-059	2
BULB,12V 8W (Ref # 92069A)	92069-1012	1
DAMPER,LICENSE LAMP (Ref # 92075)	92075-1676	1
DAMPER,LICENSE LAMP (Ref # 92075A)	92075-1694	1
COLLAR,L=6.5 (Ref # 92143)	92143-1025	2