

# 1992 Voyager XII PARTS DIAGRAM

Cruise Switch

F2769

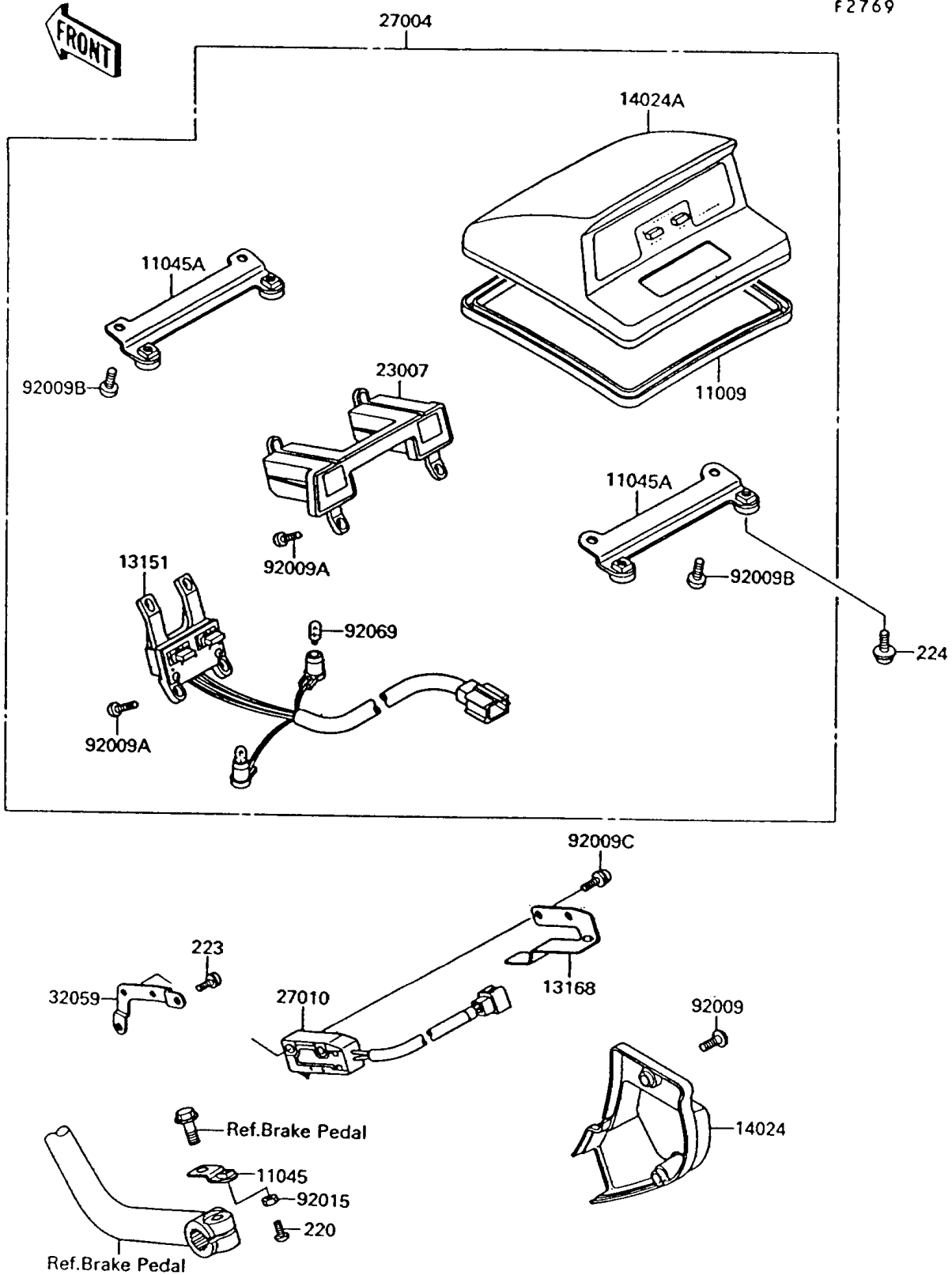

# 1992 Voyager XII PARTS LIST

## Cruise Switch

ITEM NAME	PART NUMBER	QUANTITY
SCREW-PAN-CROS (Ref # 220)	220B0416	1
SCREW-PAN-WS-CROS (Ref # 223)	223B0510	2
SCREW-PAN-WP-CROS (Ref # 224)	224B0516	4
GASKET,CRUISE CONTROL SWITCH (Ref # 11009)	11009-1682	1
BRACKET,CRUISE CANCEL SWITCH (Ref # 11045)	11045-1913	1
BRACKET,CRUISE CONTROL SWITCH (Ref # 11045A)	11045-1937	2
SWITCH-COMP,CRUISE CONTROL (Ref # 13151)	13151-1068	1
LEVER,CRUISE CANCEL SWITCH (Ref # 13168)	13168-1364	1
COVER,CRUISE CANCEL SWITCH (Ref # 14024)	14024-1539	1
COVER,CRUISE CONTROL SWITCH (Ref # 14024A)	14024-1552-6Z	1
LENS-COMP,CRUISE CONTROL (Ref # 23007)	23007-1178	1
SWITCH-ASSY,CRUISE CONTROL,BLK (Ref # 27004)	27004-1057-6Z	1
SWITCH,CRUISE CANCEL (Ref # 27010)	27010-1237	1
BRACKET-SWITCH,CRUISE CANCEL (Ref # 32059)	32059-1087	1
SCREW,5X12,BLACK (Ref # 92009)	92009-1182	2
SCREW,TAPPING,4X12 (Ref # 92009A)	92009-1395	8
SCREW,TAPPING,5X10 (Ref # 92009B)	92009-1499	4
SCREW,4X16 (Ref # 92009C)	92009-1500	2
NUT,4MM (Ref # 92015)	92015-1676	1
BULB,12V 3.4W (Ref # 92069)	92069-1007	2