

1996 Eliminator 600 PARTS DIAGRAM

Secondary Shaft

E1322

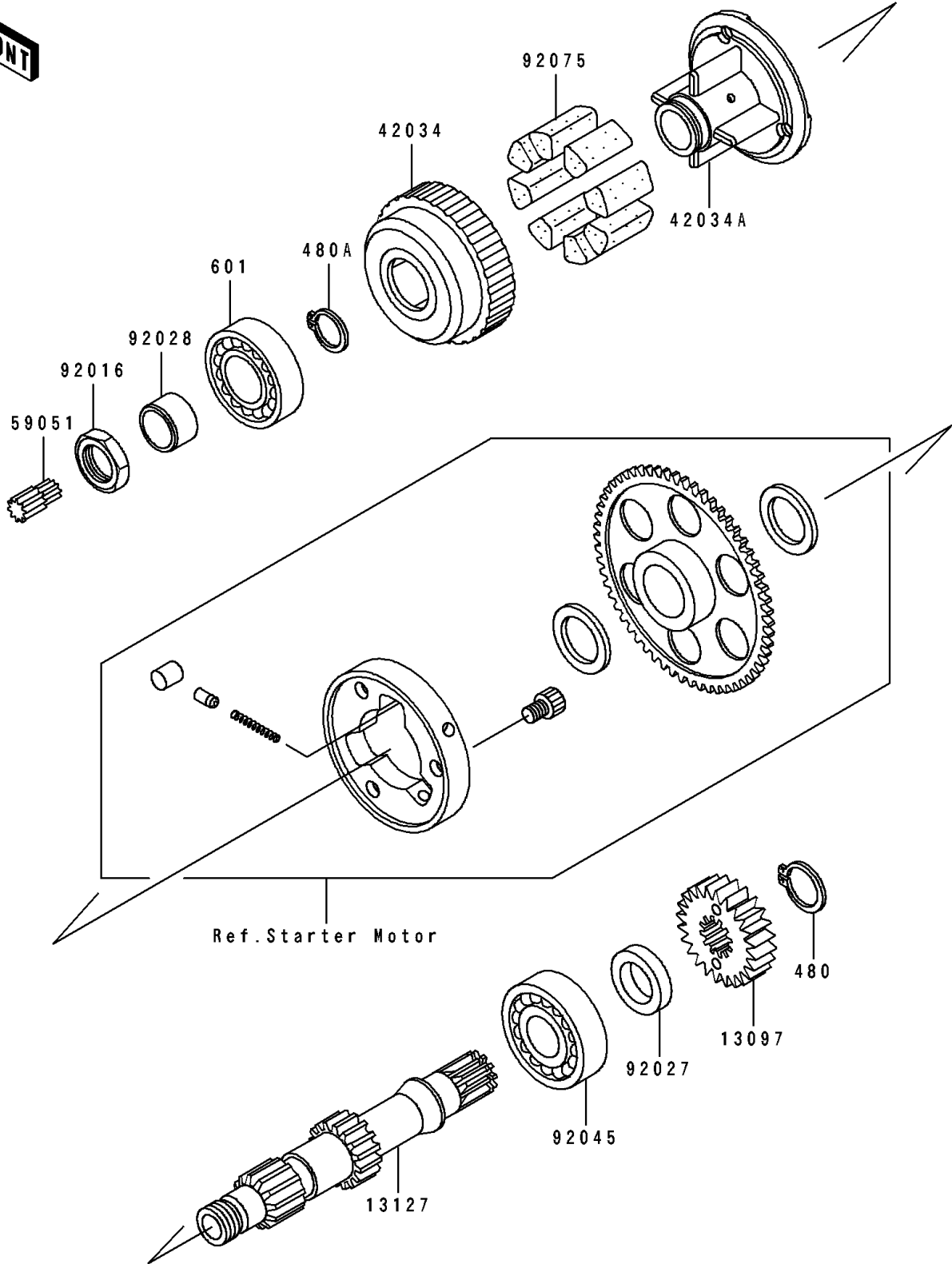

1996 Eliminator 600 PARTS LIST

Secondary Shaft

ITEM NAME	PART NUMBER	QUANTITY
GEAR-PRIMARY SPUR,28T (Ref # 13097)	13097-1141	1
SHAFT,SECONDARY (Ref # 13127)	13127-1123	1
COUPLING,OUTER,SECONDARY SHAFT (Ref # 42034)	42034-1004	1
COUPLING,INNER,SECONDARY SHAFT (Ref # 42034A)	42034-1005	1
GEAR-SPUR,10T,SECONDARY (Ref # 59051)	59051-1137	1
NUT,20MM (Ref # 92016)	92016-028	1
COLLAR,22X34X7.3 (Ref # 92027)	92027-1438	1
BUSHING,20X25X16.6 (Ref # 92028)	92028-1037	1
BEARING-BALL,#63/22X (Ref # 92045)	92045-1017	1
DAMPER,COUPLING (Ref # 92075)	92075-1070	8
CIRCLIP-TYPE-C,22MM (Ref # 480)	480J2200	1
CIRCLIP-TYPE-C,28MM (Ref # 480A)	480J2800	1
BEARING-BALL,#6205C3 (Ref # 601)	601B6205	1